



SHAH TOOLS®

MFG.: POSALUX & P.C.D. TOOLS, VACCUM TOOLS, C.N.C. TOOLS, ENDMILLS, ALL TYPE OF CARBIDE TOOLS

A BRAND YOU CAN TRUST

LATHE TURNING TOOLS



JEWELLERY DIAMOND TOOL



HAMMER DULL TOOLS



BIG ENGRAVING TOOLS

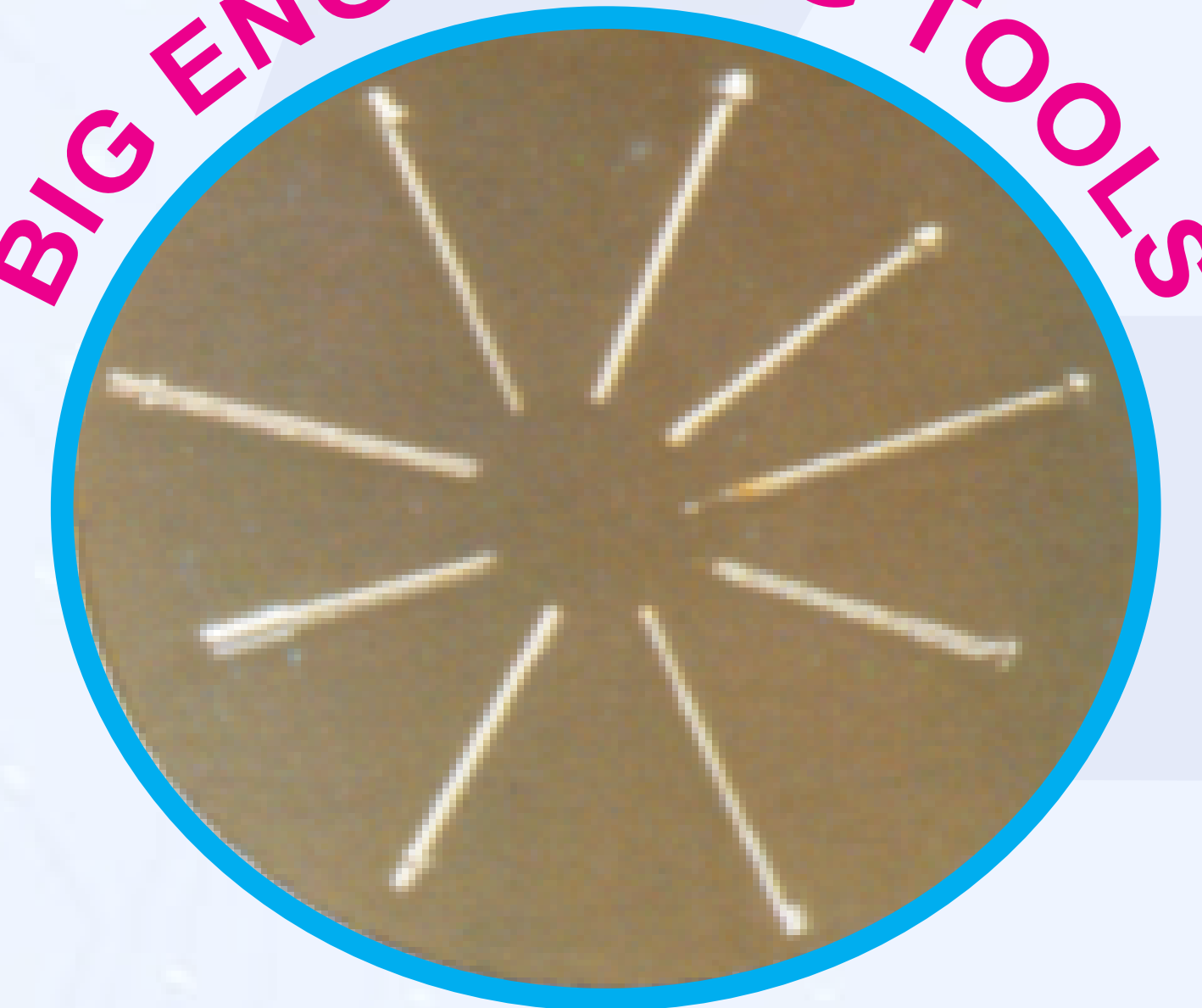

DIAMOND FLYWHEELS



HAMMER TOOLS

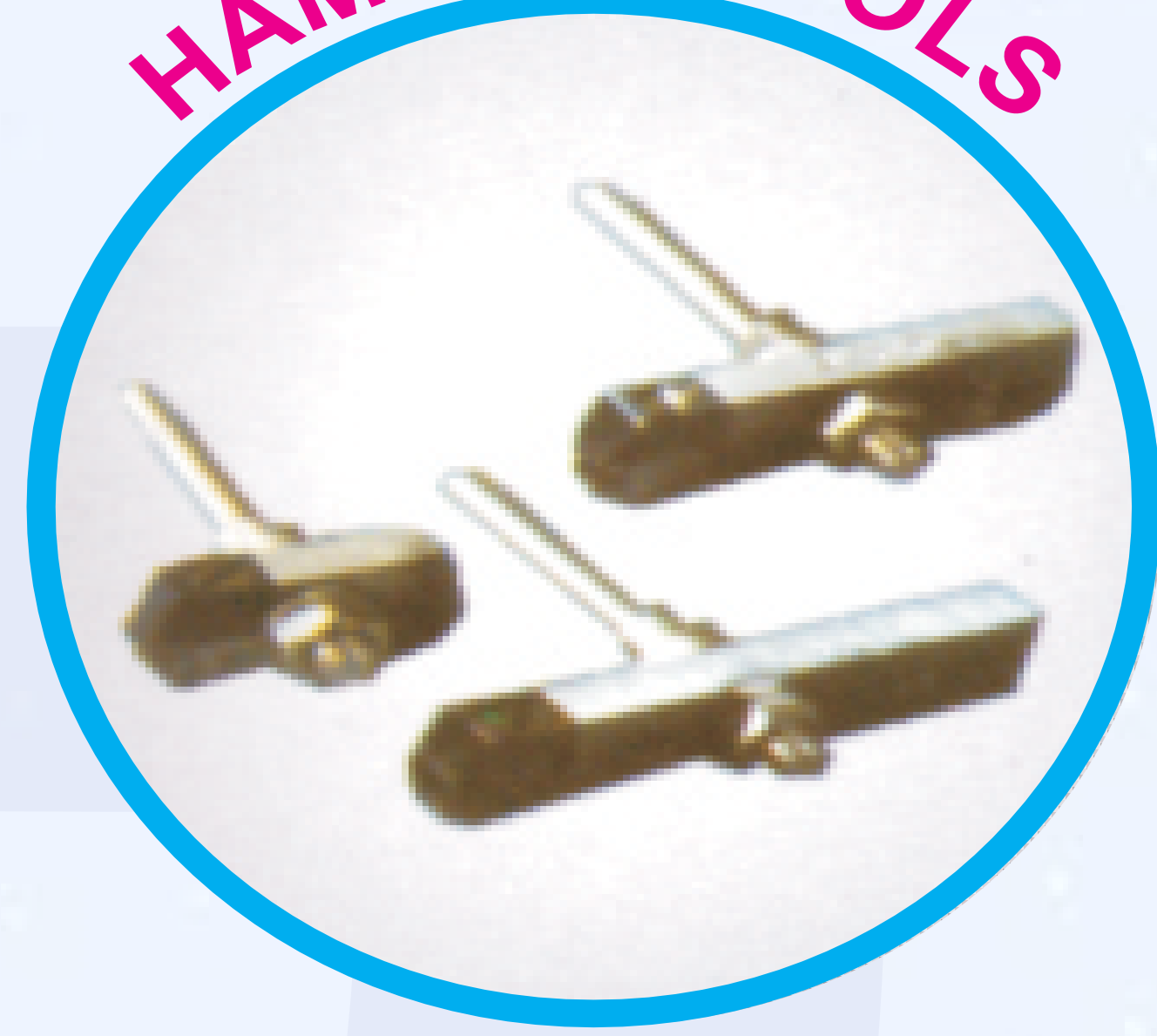

WIRE DRAW DIE

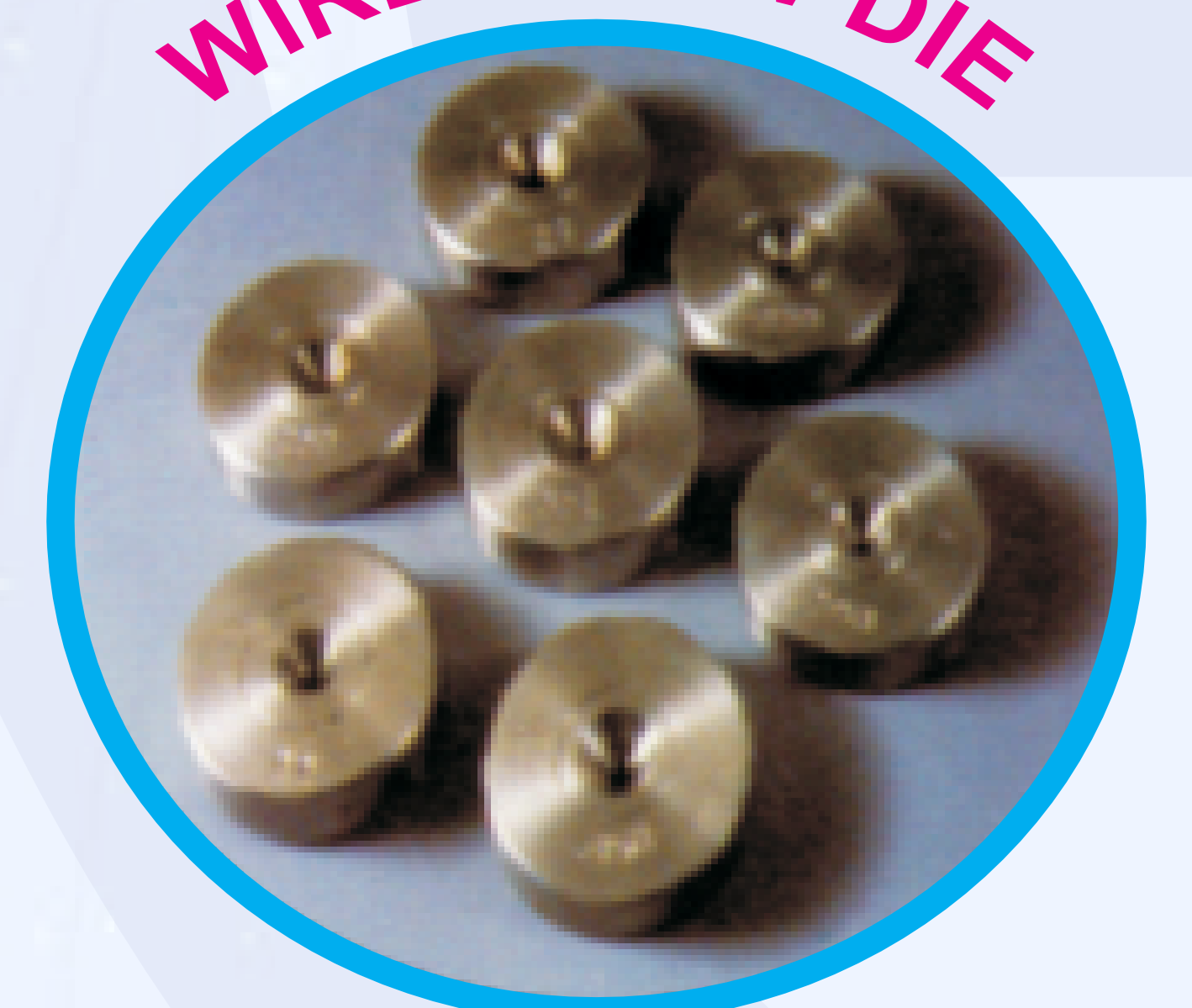

DIAMOND DULLPIN & DOTPIN



CARBON TOOLS



POSALUX TOOLS



ROUND TURNING TOOLS

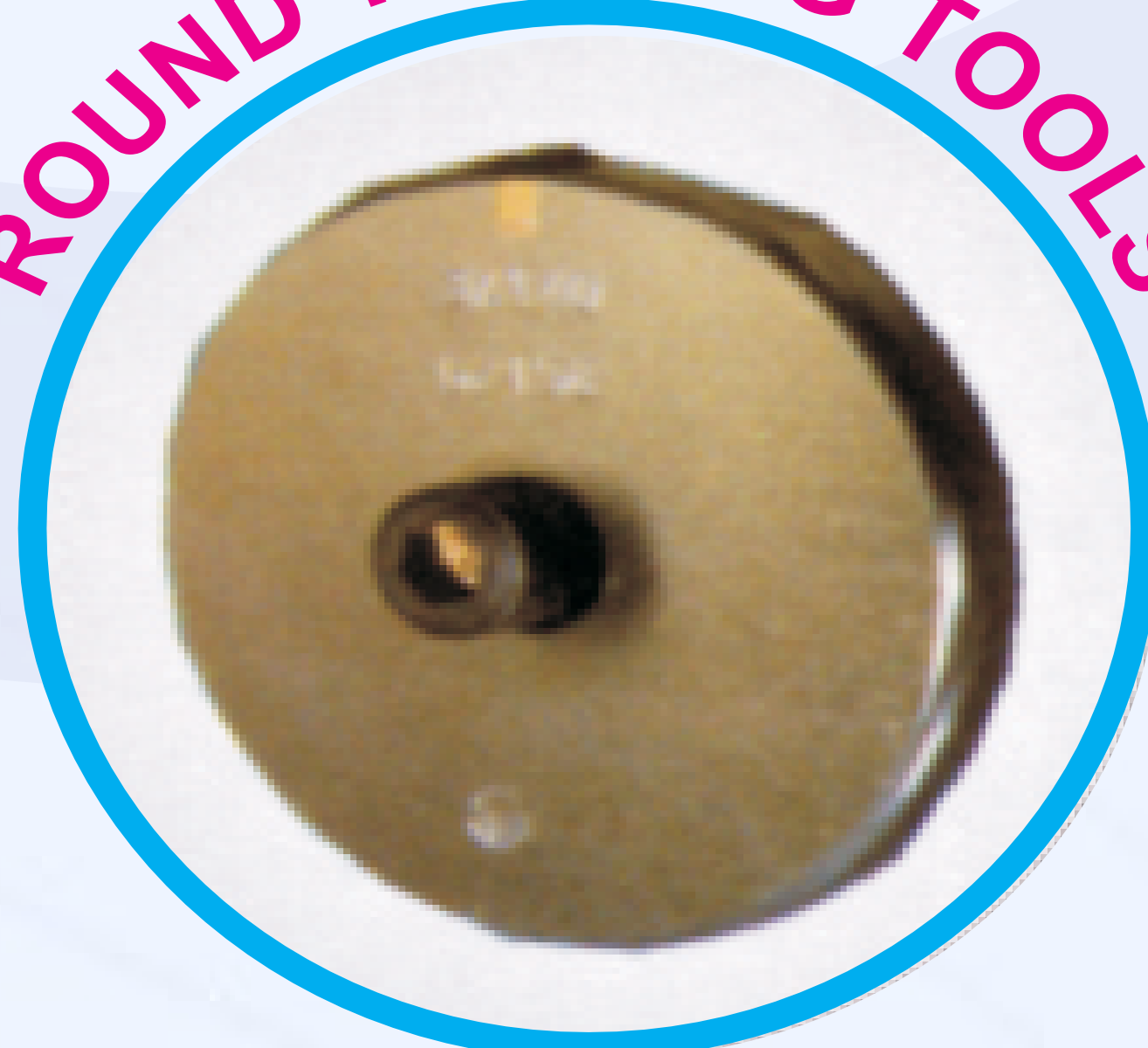

CNC TOOLS



ST



ST

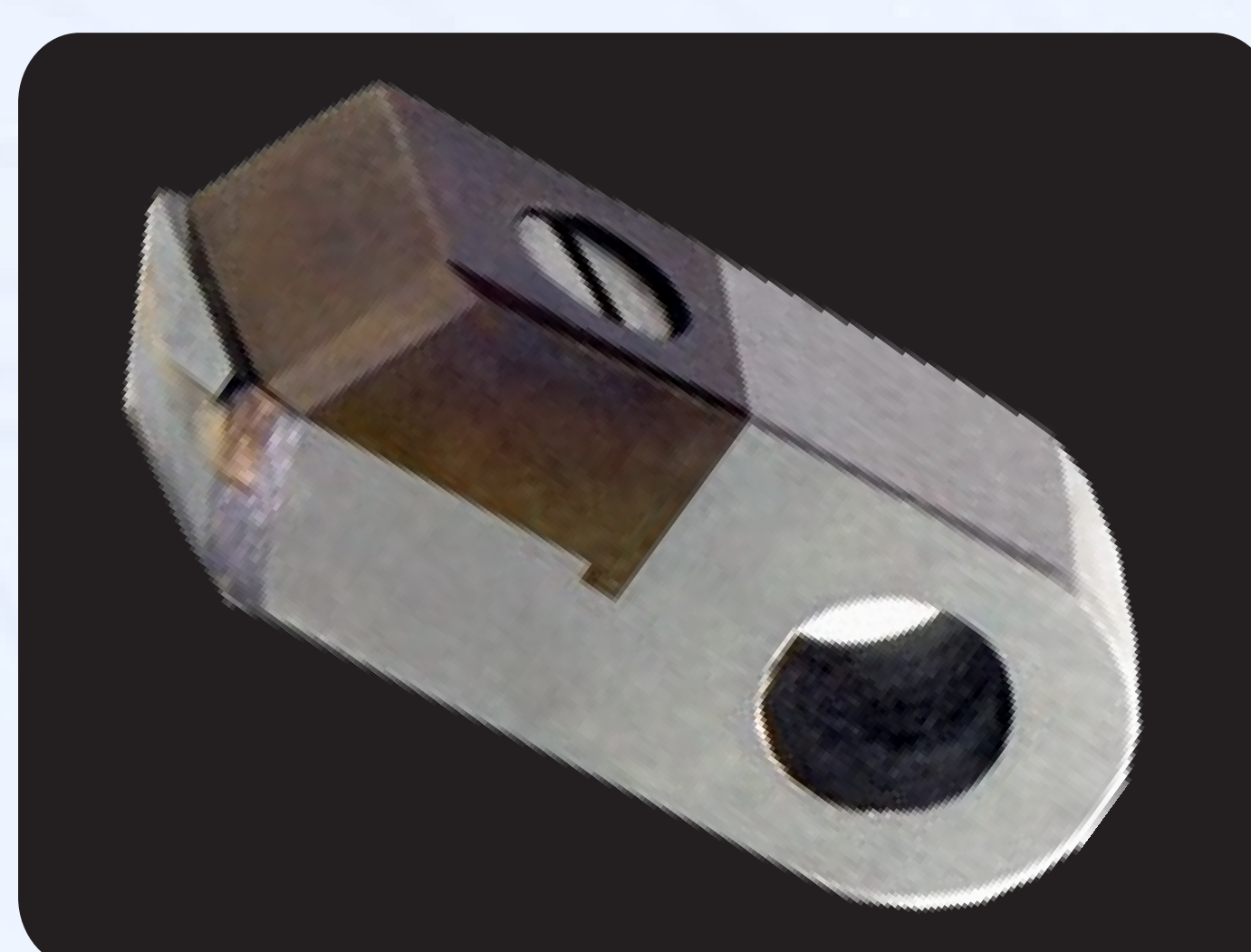

®

ST (ST) [ST] <ST> (ST) (ST) (ST)

📍 : D - 2, DMKAR CHS. LTD., PLOT NO. - 24, NEAR MANGAL MURTI HOSPITAL, NEXT TO KALA HANUMAN TEMPLE, RSC - 22, GORAI (1), BORIVALI (WEST), MUMBAI - 400 092. INDIA.

☎ : (0)+91 86558 55755 ✉ : SHAHTOOLS9@GMAIL.COM / SHAHTOOLS9@YAHOO.IN 🌐 : WWW.SHAHTOOLS.COM



SHAH TOOLS®

MFG.: POSALUX & P.C.D. TOOLS, VACCUM TOOLS, C.N.C. TOOLS, ENDMILLS, ALL TYPE OF CARBIDE TOOLS

A BRAND YOU CAN TRUST



POSALUX TOOLS:

Shapes: V (90° to 170°), flat (180°), V-flat, concave, convex, V-lining, flat lining, etc.

Sizes: 0.3mm to 10mm.

Customization : as per your Requirement



P. C. D. TOOLS:

Shapes: V (90° to 170°), flat (180°), V-flat, concave, convex, V-lining, flat lining, etc.

Sizes: 0.5mm to 20mm.

Customization : as per your Requirement

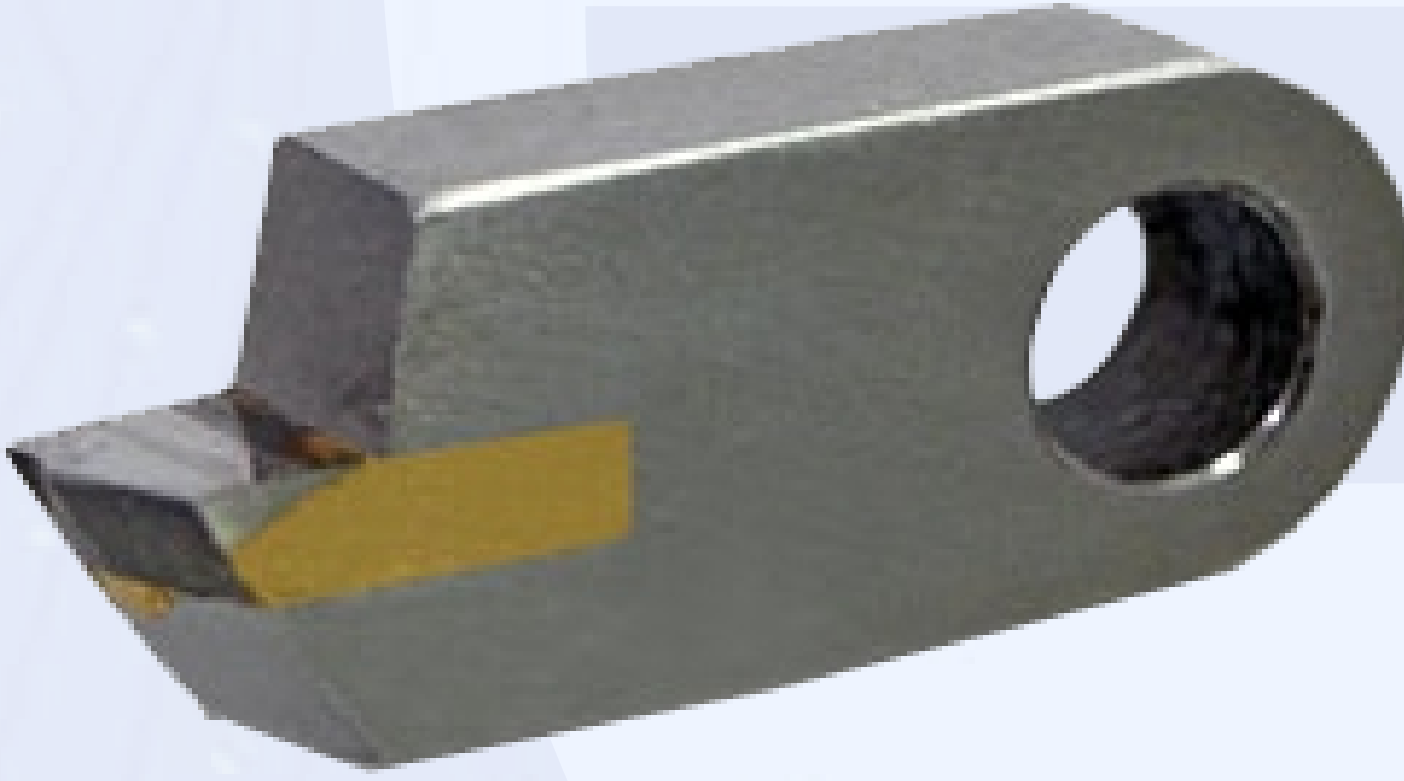

CARBON TOOLS:

Shapes: V (90° to 170°), flat (180°), V-flat, concave, convex, V-lining, flat lining, etc.

Sizes: 0.3mm to 20mm.

Customization : as per your Requirement

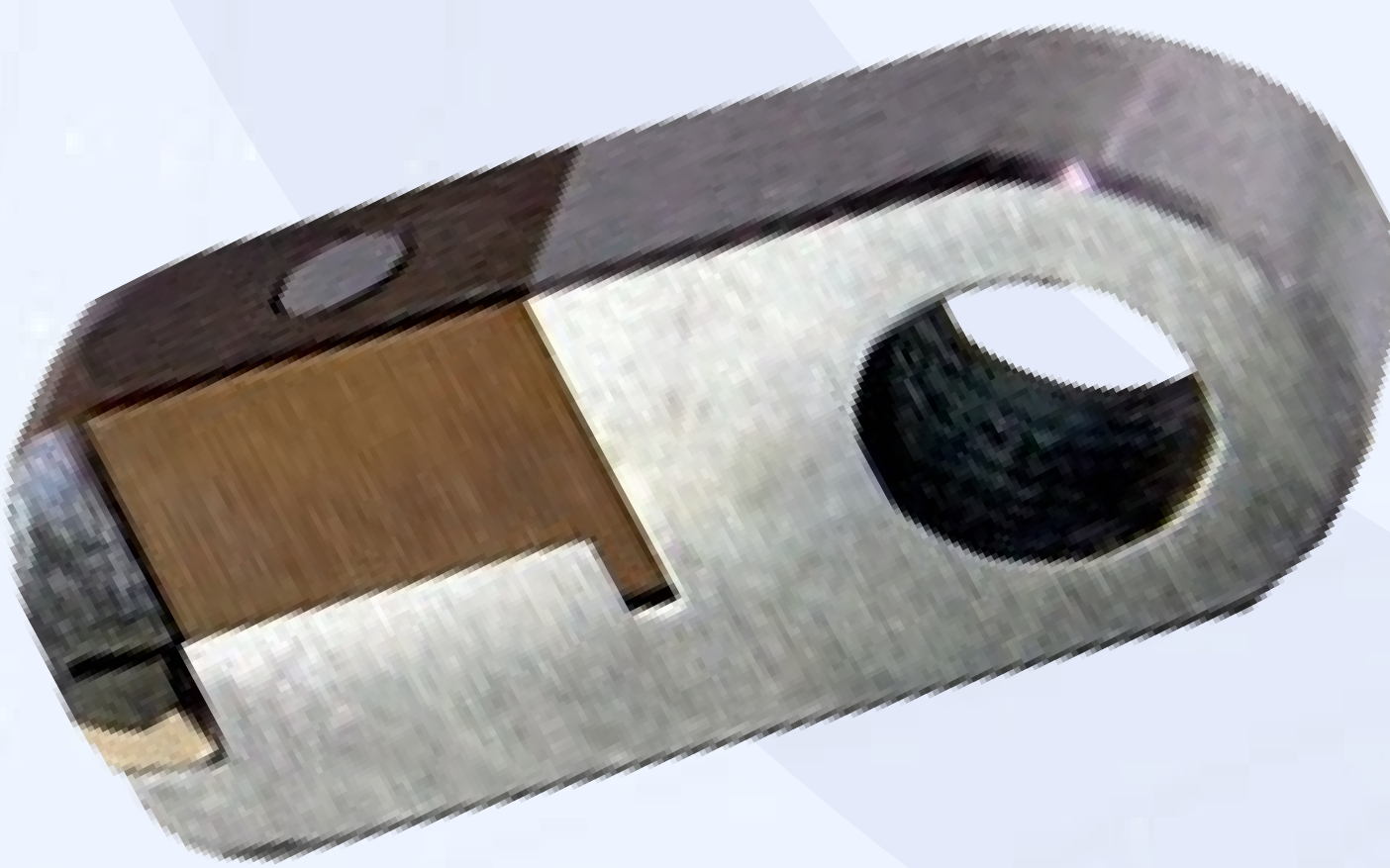

Diamond Size : all sizes

Shape : As per your requirement



Diamond Size : 1-2-3mm special use for vertical

Shape : As per your requirement



Diamond Size : 1-2-3mm special use for vertical

Shape : as per your requirement

📍 : D - 2, DMKAR CHS. LTD., PLOT NO. - 24, NEAR MANGAL MURTI HOSPITAL, NEXT TO KALA HANUMAN TEMPLE,
RSC - 22, GORAI (1), BORIVALI (WEST), MUMBAI - 400 092. INDIA.

☎ : (0)+91 86558 55755 ✉ : SHAHTOOLS9@GMAIL.COM / SHAHTOOLS9@YAHOO.IN 🌐 : WWW.SHAHTOOLS.COM



SHAH TOOLS®

MFG.: POSALUX & P.C.D. TOOLS, VACCUM TOOLS, C.N.C. TOOLS, ENDMILLS, ALL TYPE OF CARBIDE TOOLS

A BRAND YOU CAN TRUST

HAMMER TOOLS:



Shapes: V (90° to 170°), flat (180°), V-flat, concave, convex, V-lining, flat lining, etc.

Sizes: 0.3mm to 4.0 mm.

Tool Length : 14, 16, 18, 20, 25.

Stick Size : 2.3 mm & 3.0 mm

Customization : as per your Requirement



HAND VERTICAL TOOLS:

Shape : Bindi, Chand, Jalebi, Football Circle etc.

Size : 0.5 mm to 5.0 mm

Stick Size : 2.3 mm & 3.0 mm

Customization : as per your Requirement

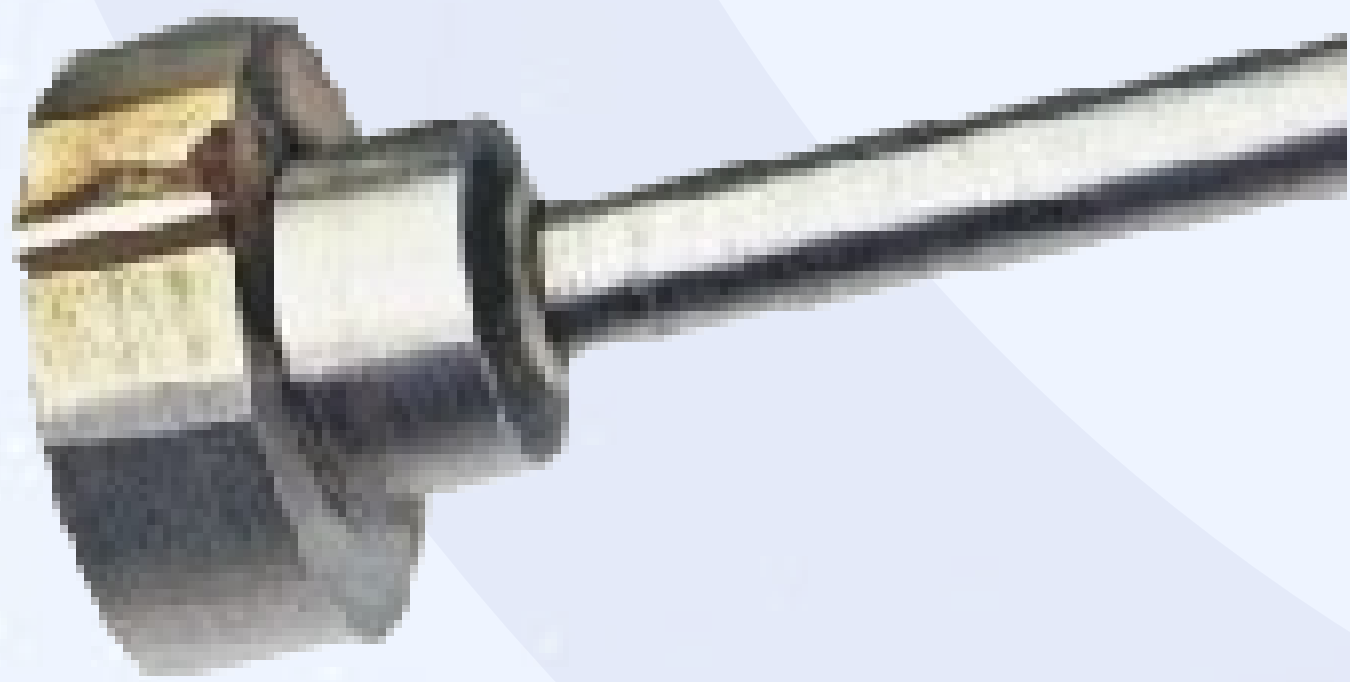

FLYWHEEL (BUTTON) TOOLS:

Shapes: V (90° to 170°), flat (180°), V-flat, concave, convex, V-lining, flat lining, etc.

Sizes: 0.3mm to 4.0 mm.

Stick Size : 2.3 mm & 3.0 mm

Customization : as per your Requirement



TURNING TOOLS:

Shapes : As per your requirement

Diamond Sizes : As per your requirement



HARDING TOOLS:

Shape : as per your requirement

📍 : D - 2, DMKAR CHS. LTD., PLOT NO. - 24, NEAR MANGAL MURTI HOSPITAL, NEXT TO KALA HANUMAN TEMPLE,
RSC - 22, GORAI (1), BORIVALI (WEST), MUMBAI - 400 092. INDIA.

☎ : (0)+91 86558 55755 ✉ : SHAHTOOLS9@GMAIL.COM / SHAHTOOLS9@YAHOO.IN 🌐 : WWW.SHAHTOOLS.COM



SHAH TOOLS®

MFG.: POSALUX & P.C.D. TOOLS, VACCUM TOOLS, C.N.C. TOOLS, ENDMILLS, ALL TYPE OF CARBIDE TOOLS

A BRAND YOU CAN TRUST

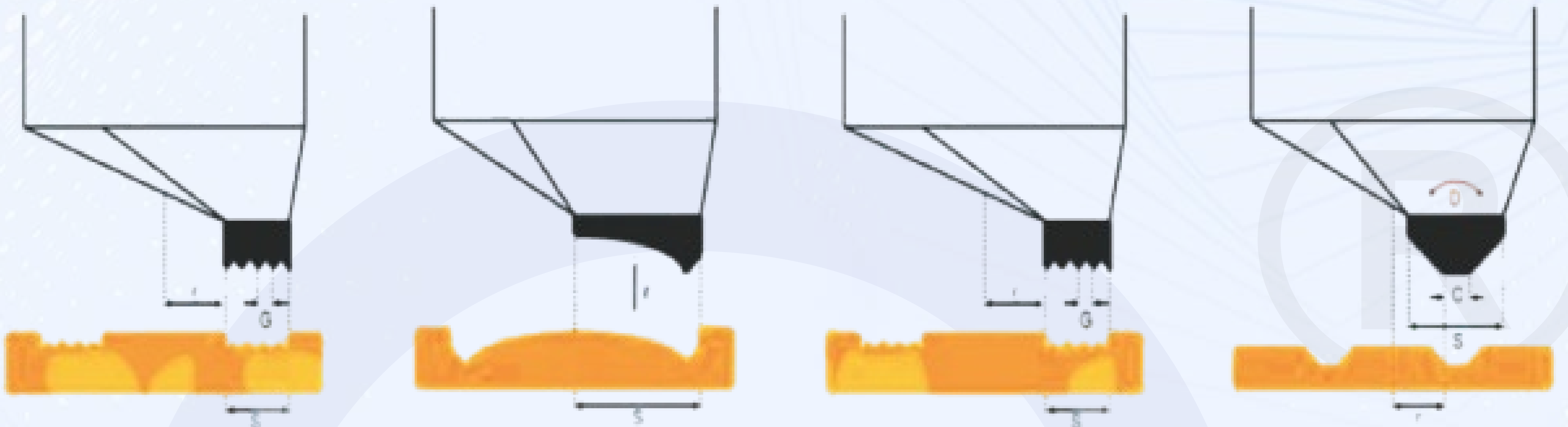

1 2 3 4

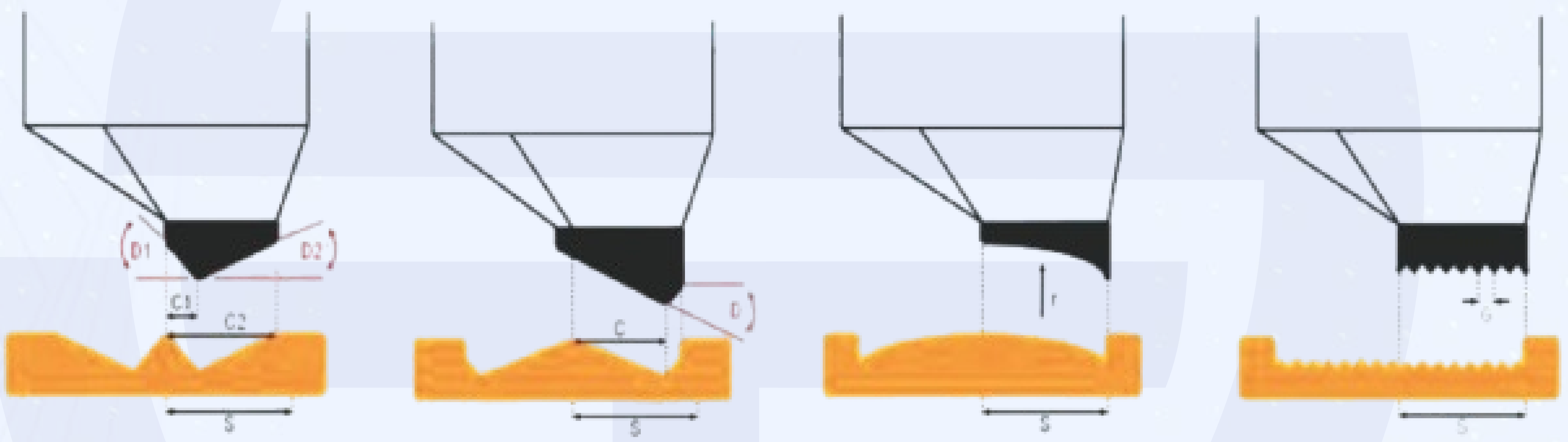

5 6 7 8



📍 : D - 2, DMKAR CHS. LTD., PLOT NO. - 24, NEAR MANGAL MURTI HOSPITAL, NEXT TO KALA HANUMAN TEMPLE, RSC - 22, GORAI (1), BORIVALI (WEST), MUMBAI - 400 092. INDIA.

☎ : (0)+91 86558 55755 ✉ : SHAHTOOLS9@GMAIL.COM / SHAHTOOLS9@YAHOO.IN 🌐 : WWW.SHAHTOOLS.COM



SHAH TOOLS®

MFG.: POSALUX & P.C.D. TOOLS, VACCUM TOOLS, C.N.C. TOOLS, ENDMILLS, ALL TYPE OF CARBIDE TOOLS

A BRAND YOU CAN TRUST



FLY DISC TOOLS:

Diamond Size : 1 to 4 mm

Disk size: 12mm, 15mm, 20mm, 25mm, 30mm, 40mm



WIRE DRAWING DIE:

Diamond hole Size:

DIAMETER S W G 16 upto 42

DIAMETER IN INCH 0.064 upto 0.0068

DIAMETER IN MM 1.6256 upto 0.1016



DIAMOND DISC TOOLS:

Diamond Size : 1 to 4 mm

Disk size : 12mm, 15mm, 20mm, 25mm, 30mm, 40mm

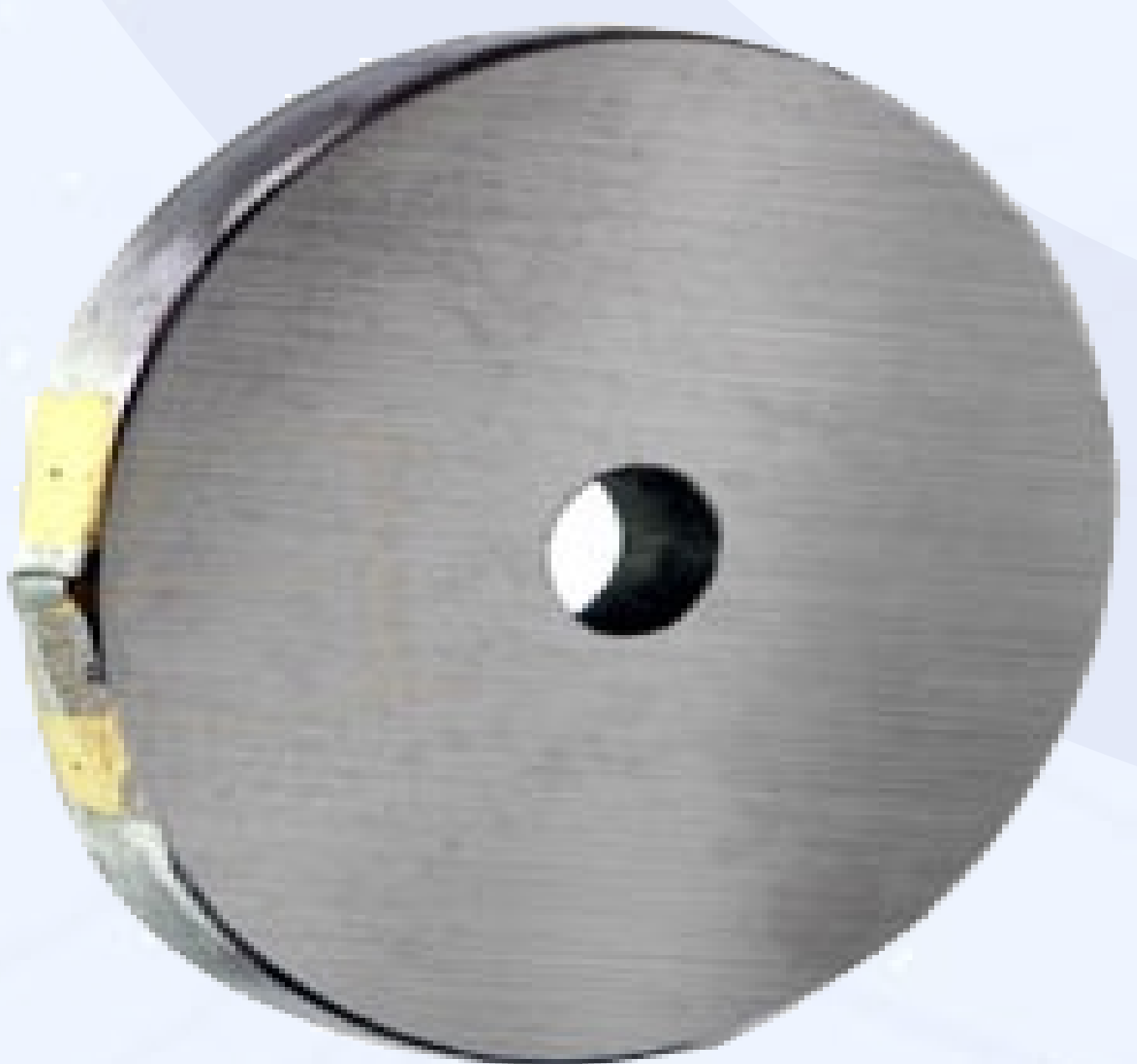

P. C. D. DISC TOOLS:

Diamond Size : 1 to 4 mm

Disk size: 8mm, 10mm, 12mm, 15mm, 20mm, 25mm, 30mm, 40mm

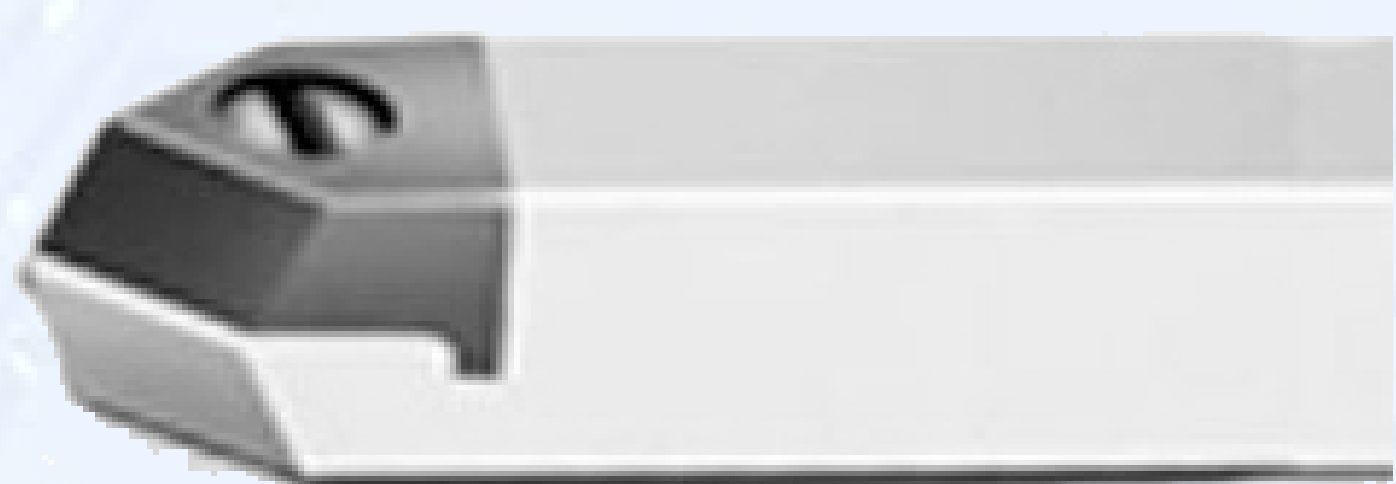

LATHE TOOLS :

Degrees : 110° to 180° flat

Diamond Sizes : 1mm to 6mm

Shank Sizes : As per your requirement

Position of Diamond : Front and Side

Customization : as per your Requirement

📍 : D - 2, DMKAR CHS. LTD., PLOT NO. - 24, NEAR MANGAL MURTI HOSPITAL, NEXT TO KALA HANUMAN TEMPLE,
RSC - 22, GORAI (1), BORIVALI (WEST), MUMBAI - 400 092. INDIA.

☎ : (0)+91 86558 55755 ✉ : SHAHTOOLS9@GMAIL.COM / SHAHTOOLS9@YAHOO.IN 🌐 : WWW.SHAHTOOLS.COM



SHAH TOOLS®

MFG.: POSALUX & P.C.D. TOOLS, VACCUM TOOLS, C.N.C. TOOLS, ENDMILLS, ALL TYPE OF CARBIDE TOOLS

A BRAND YOU CAN TRUST



Shape : as per your requirement

Degrees : 110° to 180° flat

Diamond Sizes : 1mm to 6mm

Shank Sizes : As per your requirment

Position of Diamond : Front and Side as per your requirement

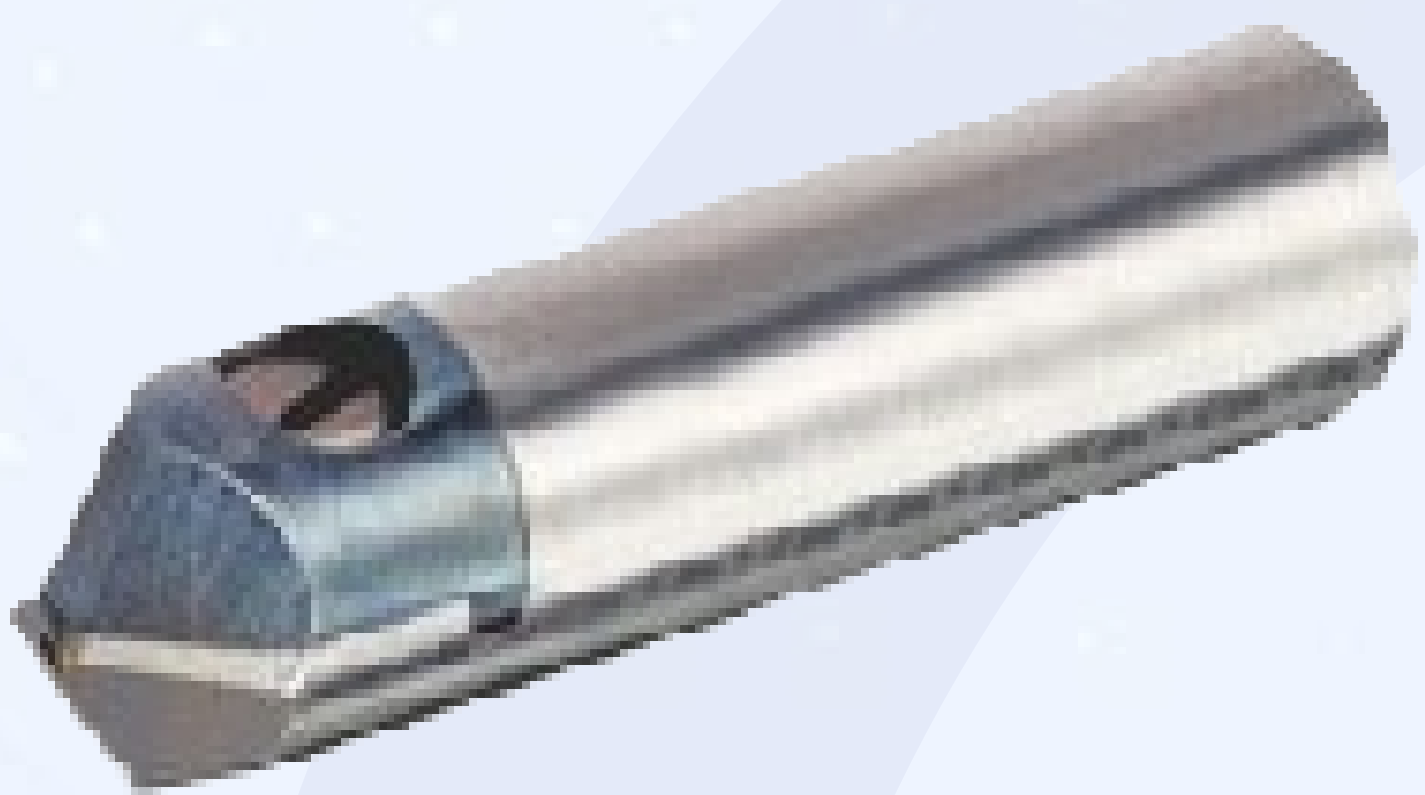

Shapes : V 110° to 180° flat, V-flat, concave, convex, V-lining, flat lining, etc.

Sizes: 1mm to 4mm

Shank Sizes : Standard 3mm, 4mm and 6mm As per your Requirement



Shape : as per your requirement

Degrees : 110° to 180° flat

Sizes : 1mm to 6mm

Shank Sizes : 100 x 10 x 10 and 120 x 12 x 12

Position of Diamond : Front and Side as per your requirement

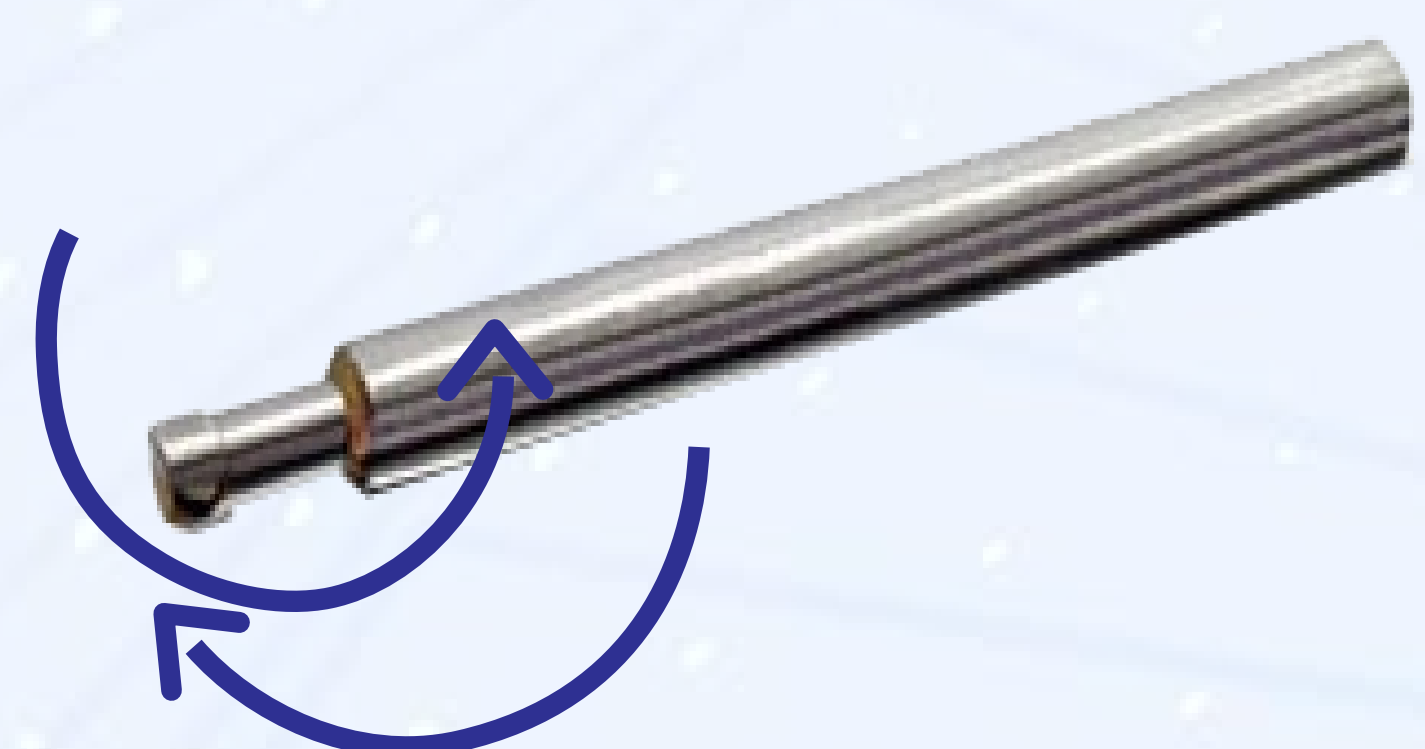
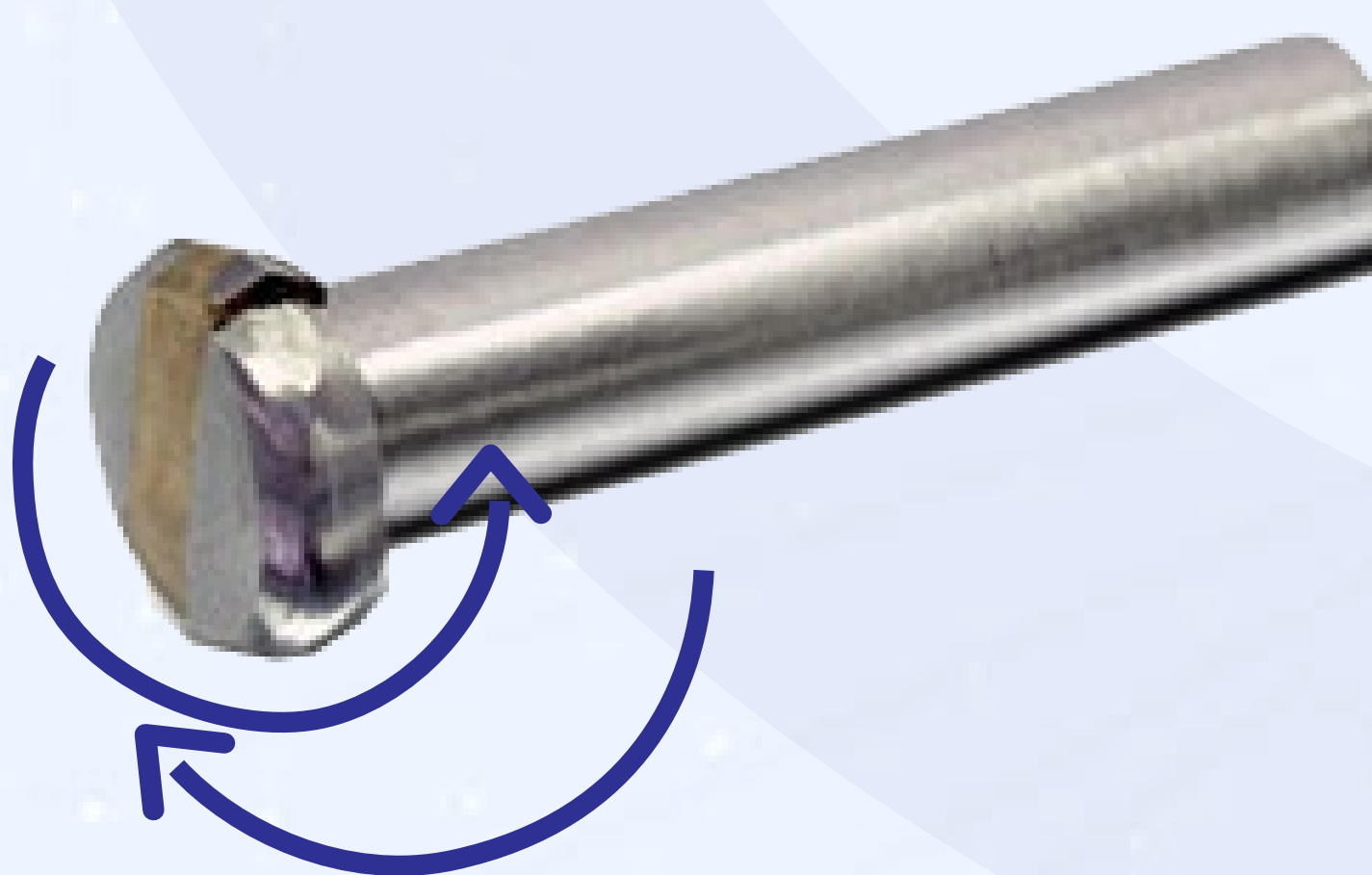

Diamond Size : as per your requirement

Shank Size: Standard 2.35mm, 3 mm, Make to Order

Shapes : V 110° to 180° flat, V-flat, concave, convex,
V-lining, flat lining, etc.

Sizes : 1mm to 4mm.

Shank Sizes : Standard 2.35mm, 3 mm, Make to Order

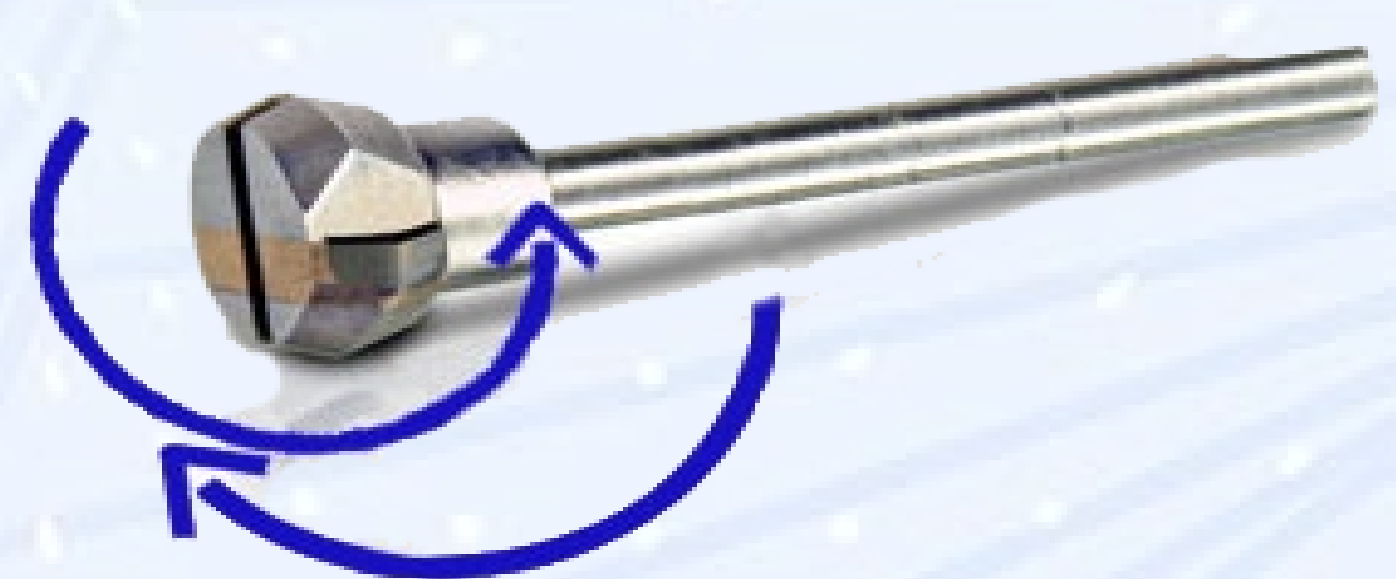

📍 : D - 2, OMKAR CHS. LTD., PLOT NO. - 24, NEAR MANGAL MURTI HOSPITAL, NEXT TO KALA HANUMAN TEMPLE,
RSC - 22, GORAI (1), BORIVALI (WEST), MUMBAI - 400 092. INDIA.

☎ : (0)+91 86558 55755 ✉ : SHAHTOOLS9@GMAIL.COM / SHAHTOOLS9@YAHOO.IN 🌐 : WWW.SHAHTOOLS.COM



SHAH TOOLS®

MFG.: POSALUX & P.C.D. TOOLS, VACCUM TOOLS, C.N.C. TOOLS, ENDMILLS, ALL TYPE OF CARBIDE TOOLS

A BRAND YOU CAN TRUST

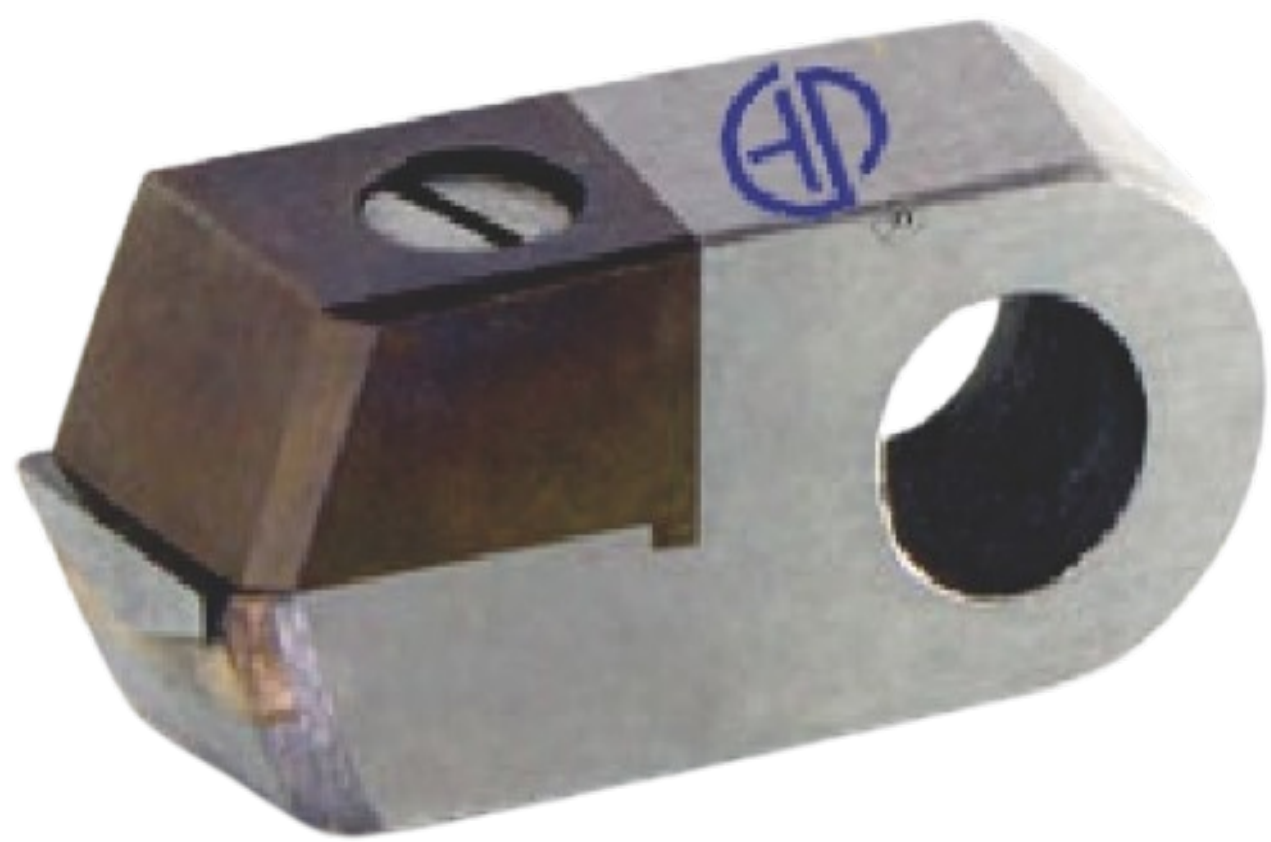

Posalux Tools



Posalux Tools



Hammer Tools



Diamond / P.C.D Disc Tool



Diamond / P.C.D Disc Tools

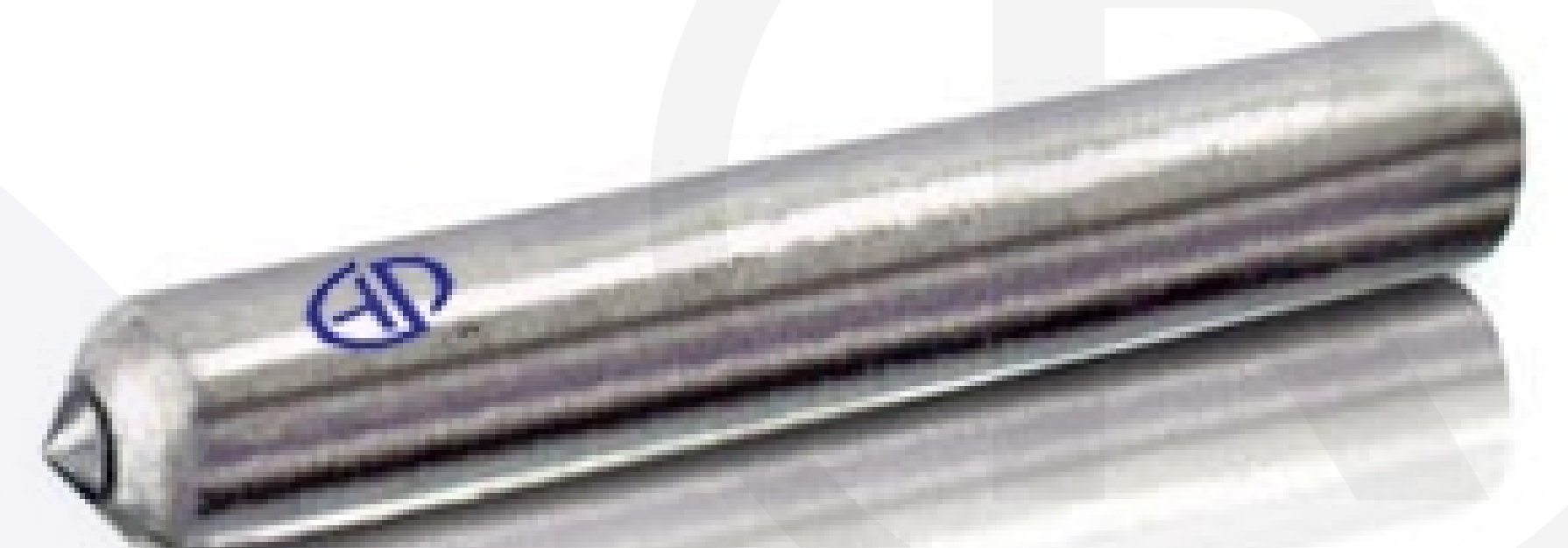

Hardness Cone Tools

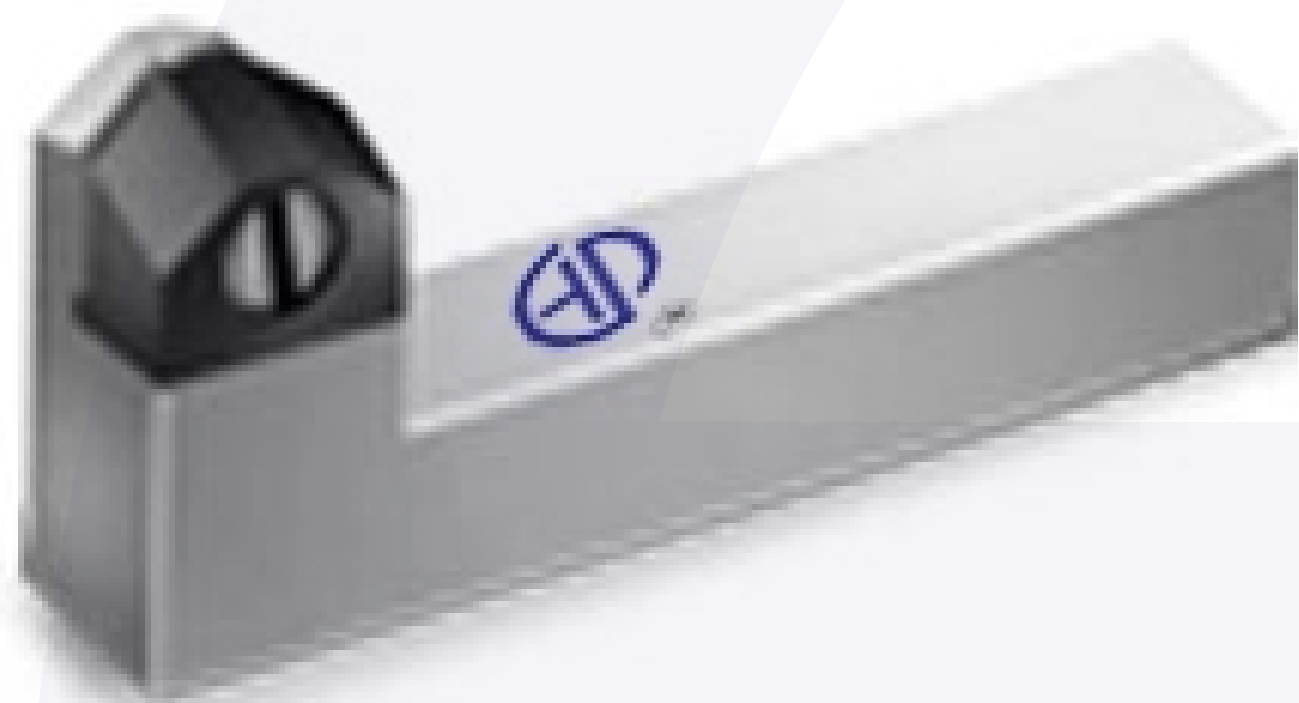

ICE Lathe Angle Tools



ICE Lathe Boring Tools



C.N.C. Tools



Hardness Checking Tools



P.C.D. Tools

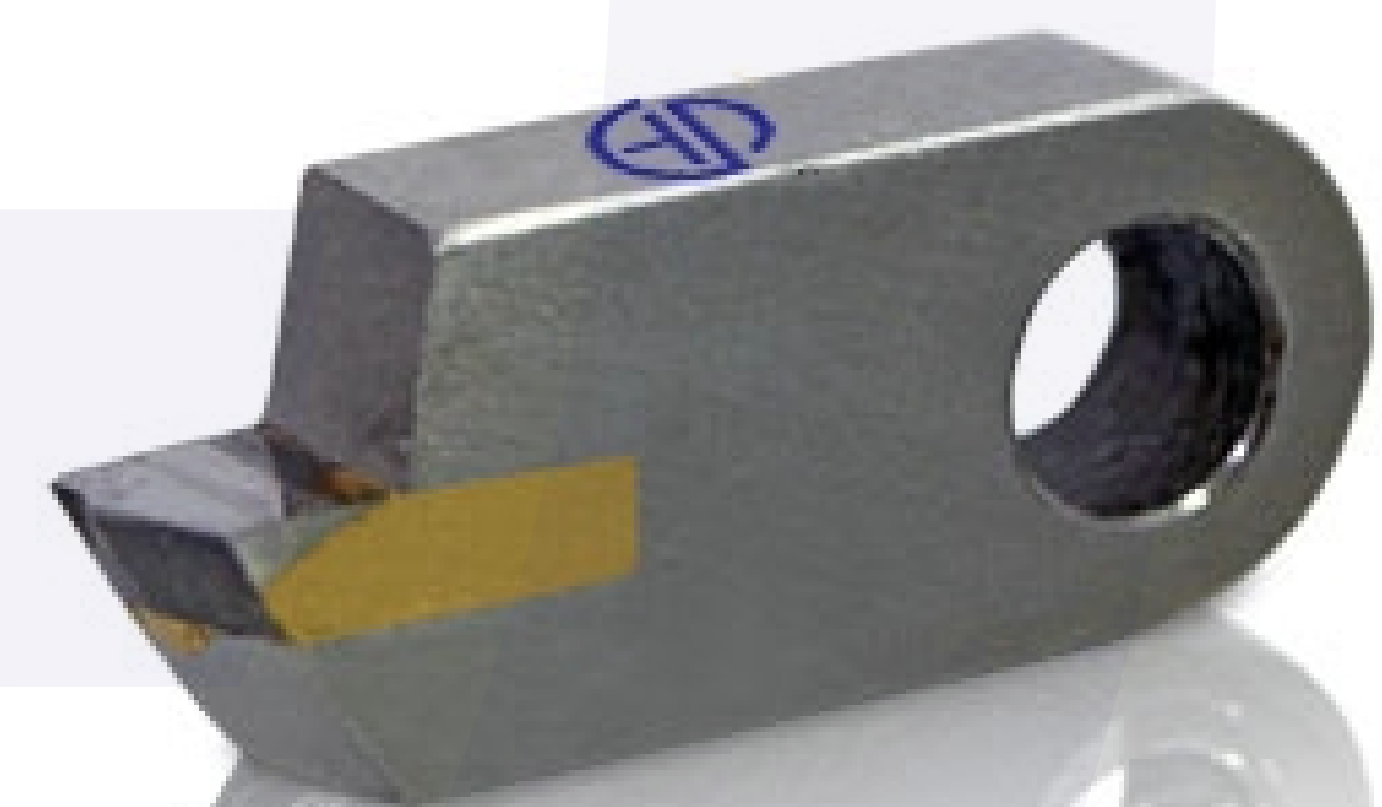

Carbon Tools



Flywheel



Flywheel Changeable Tools



Inside Turning Tools



Wire Drawing Die Diamond



Watch Tools



ICE Lathe Tools



Lathe Boring Marking Tools



C.N.C. TOOLS



Hardness Cone Tools

📍 : D - 2, DMKAR CHS. LTD., PLOT NO. - 24, NEAR MANGAL MURTI HOSPITAL, NEXT TO KALA HANUMAN TEMPLE, RSC - 22, GORAI (1), BORIVALI (WEST), MUMBAI - 400 092. INDIA.











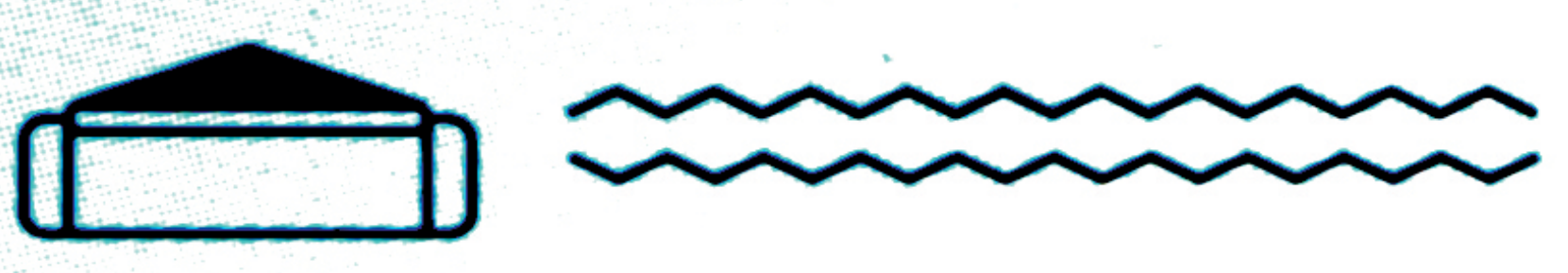
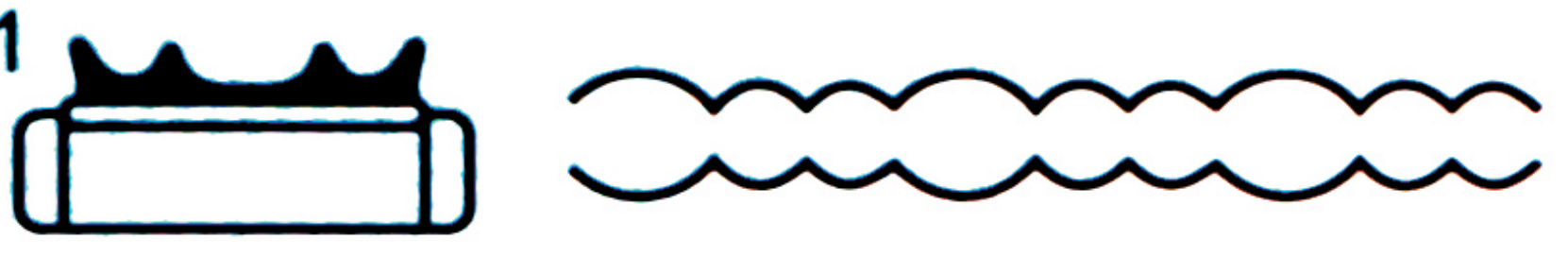
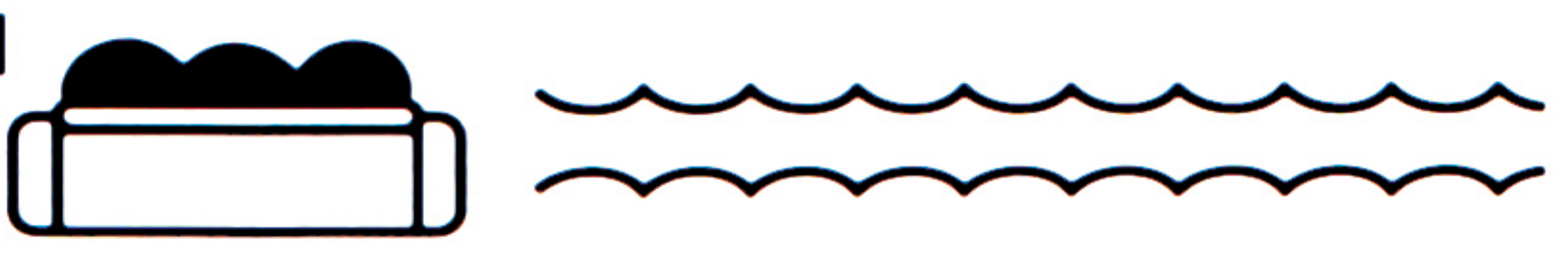
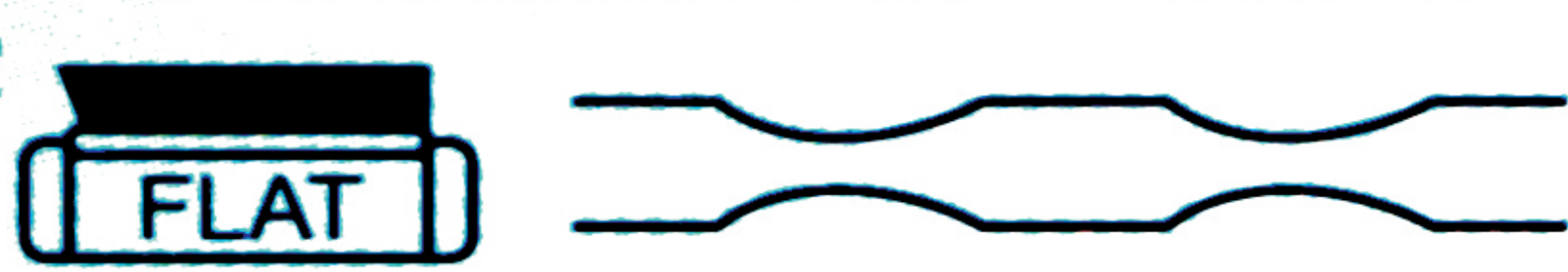
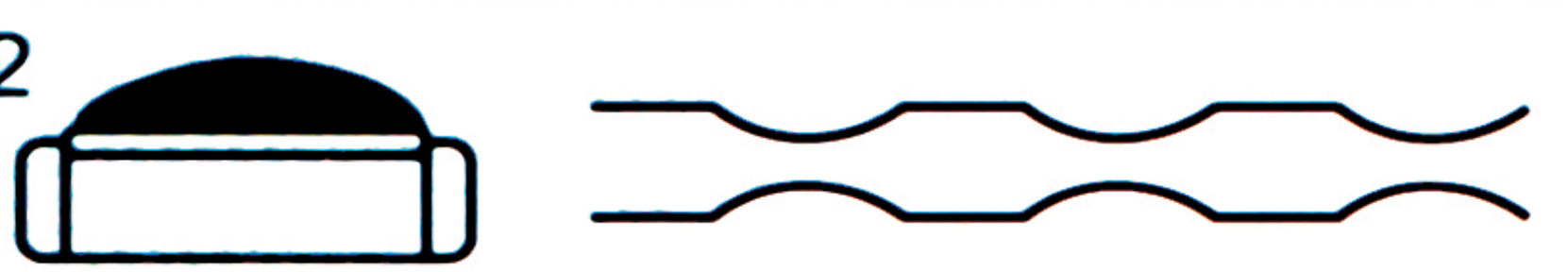
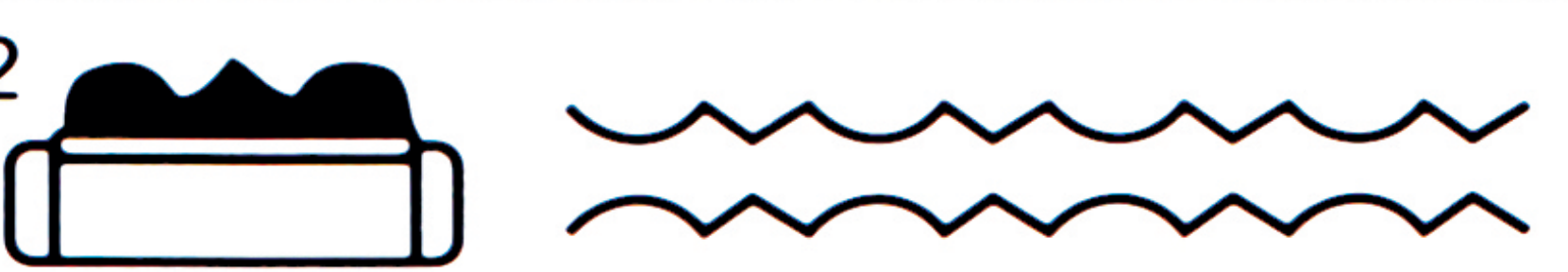

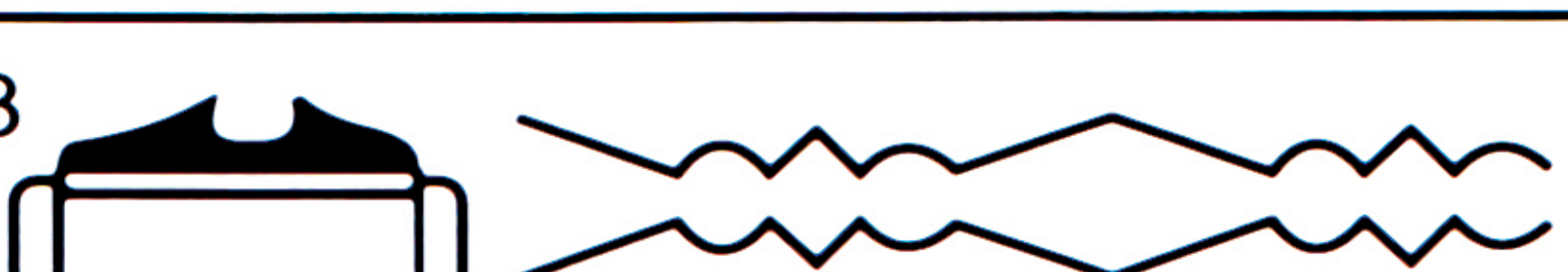
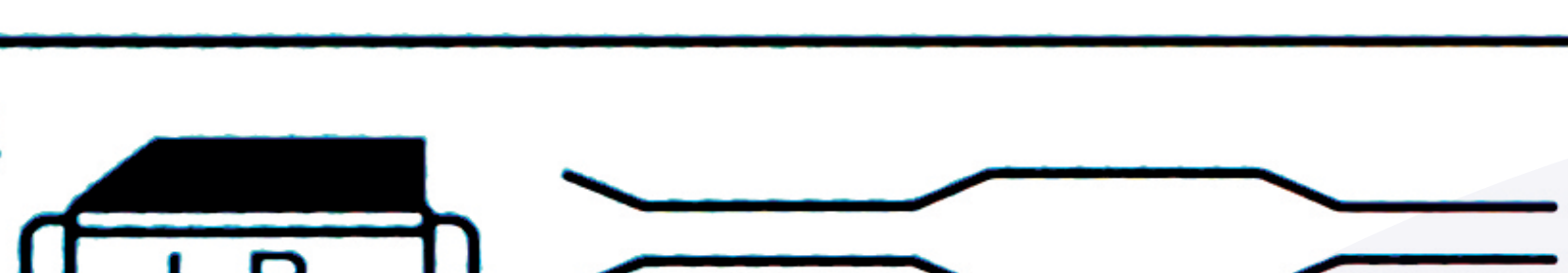

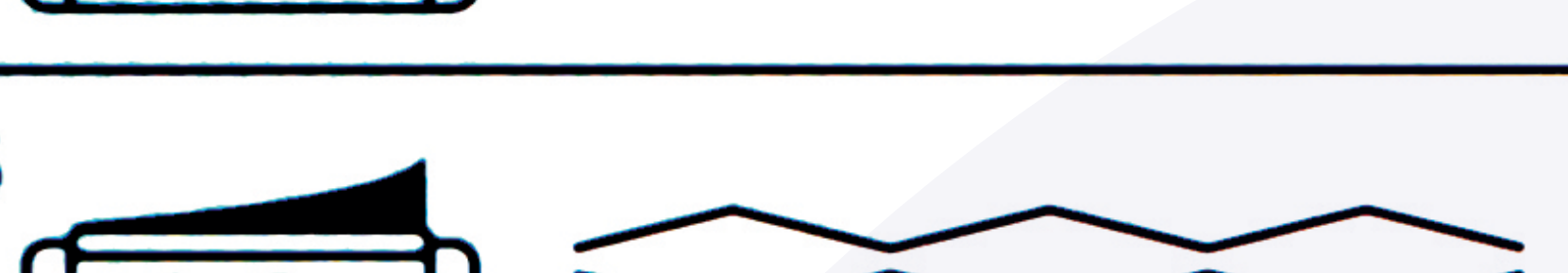
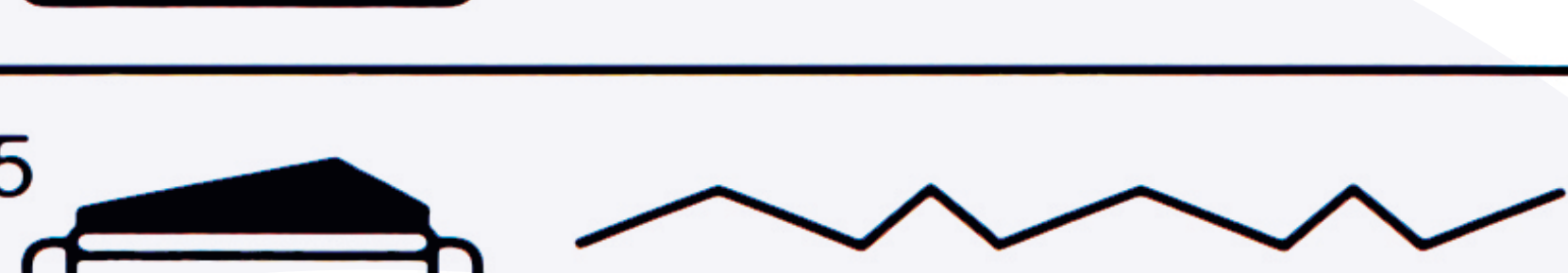



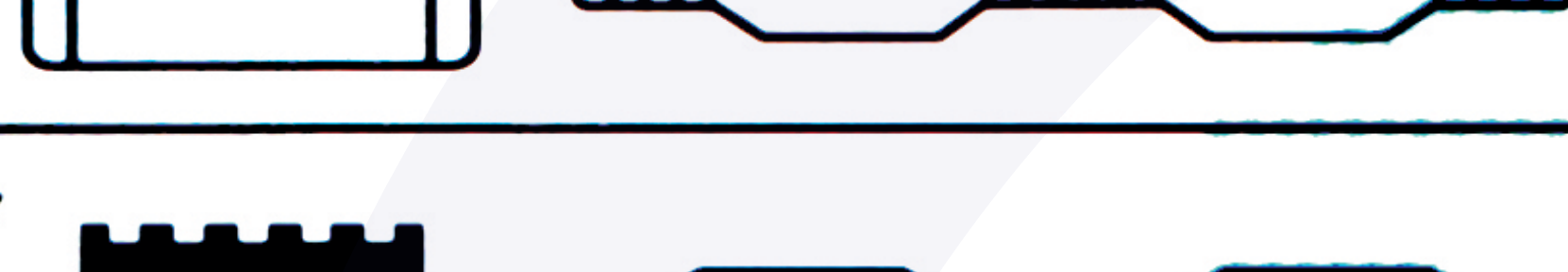



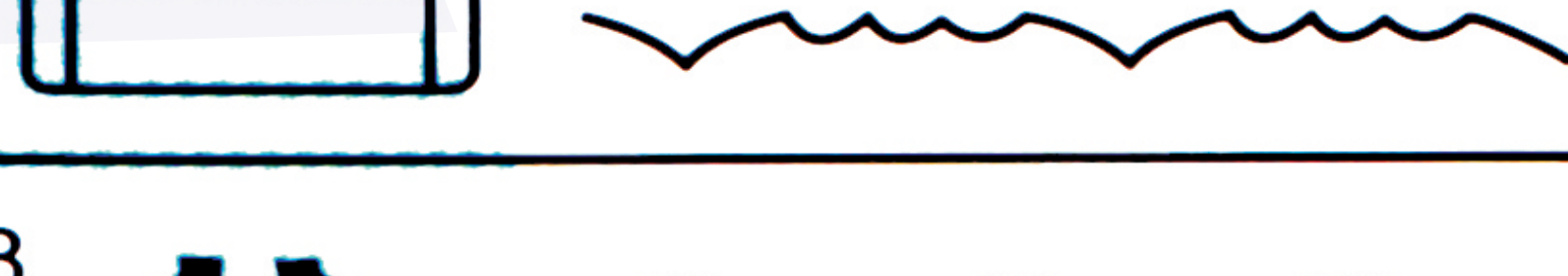

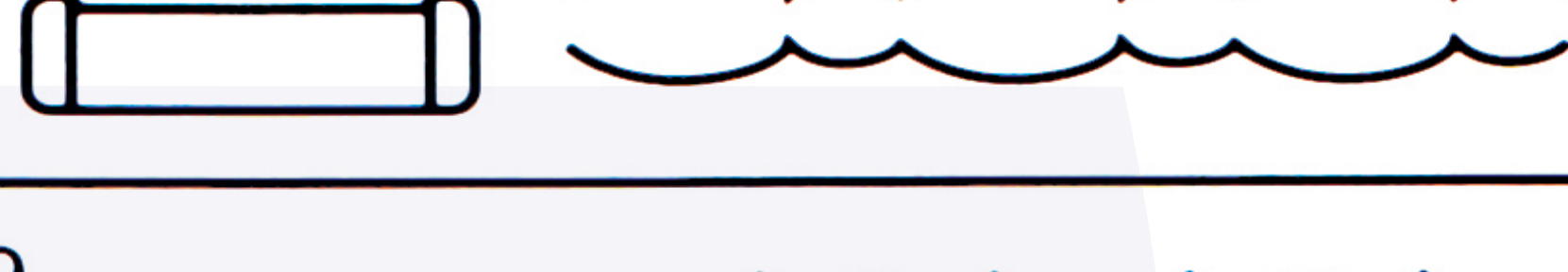

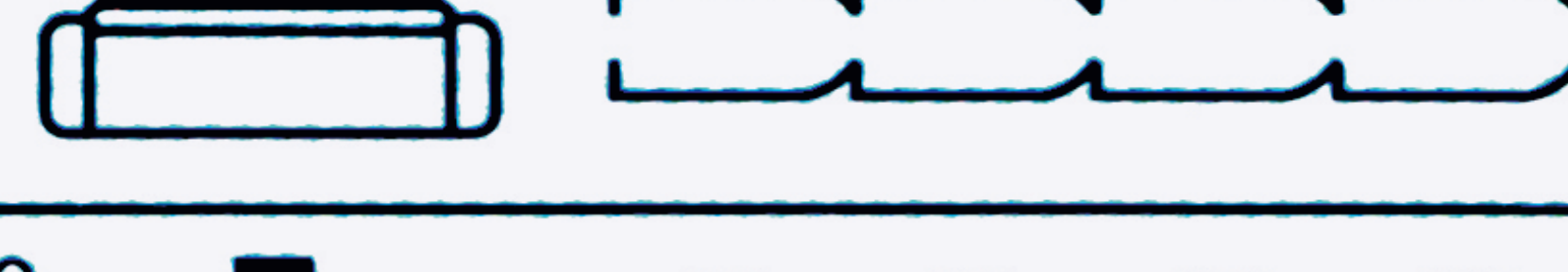
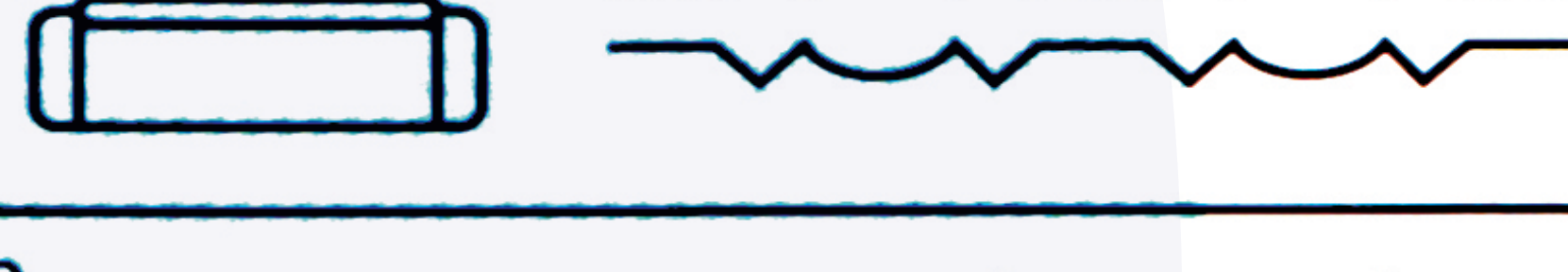
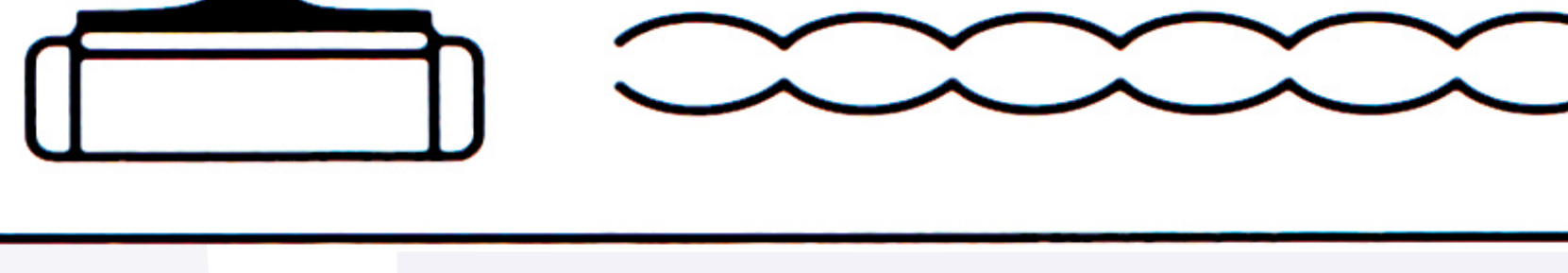

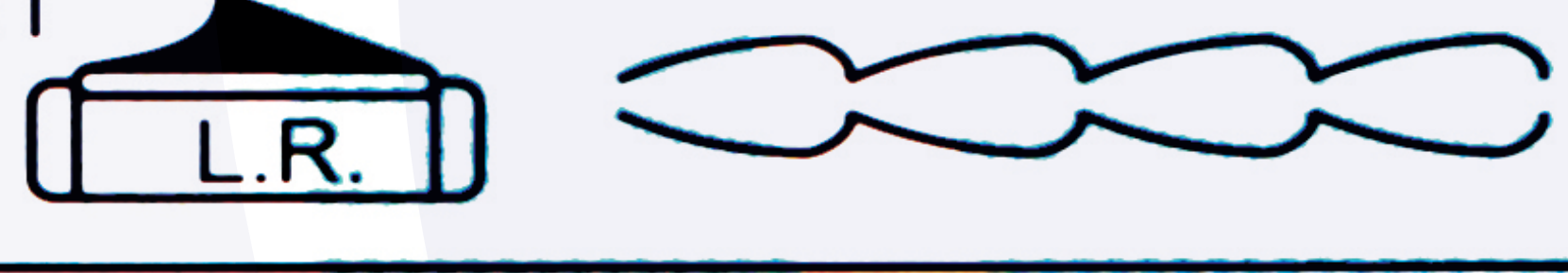

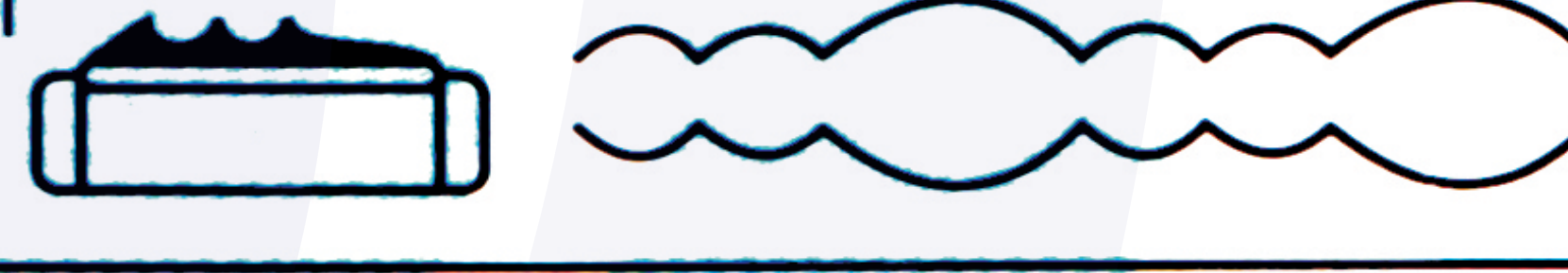
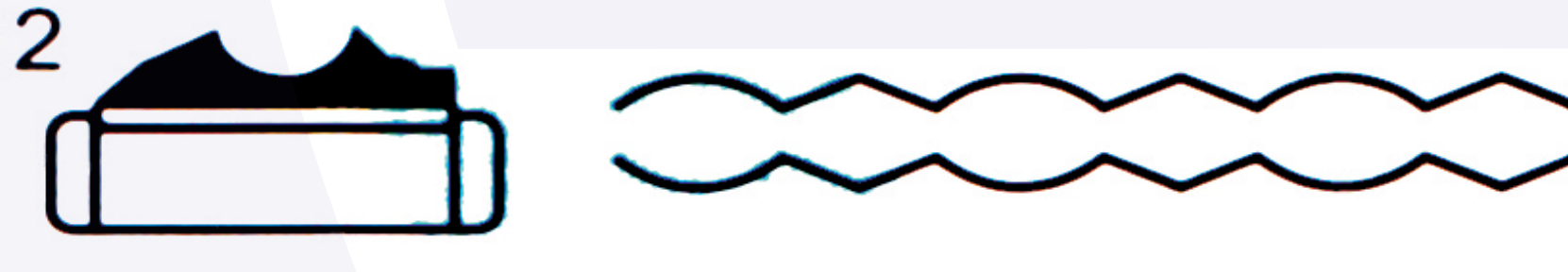
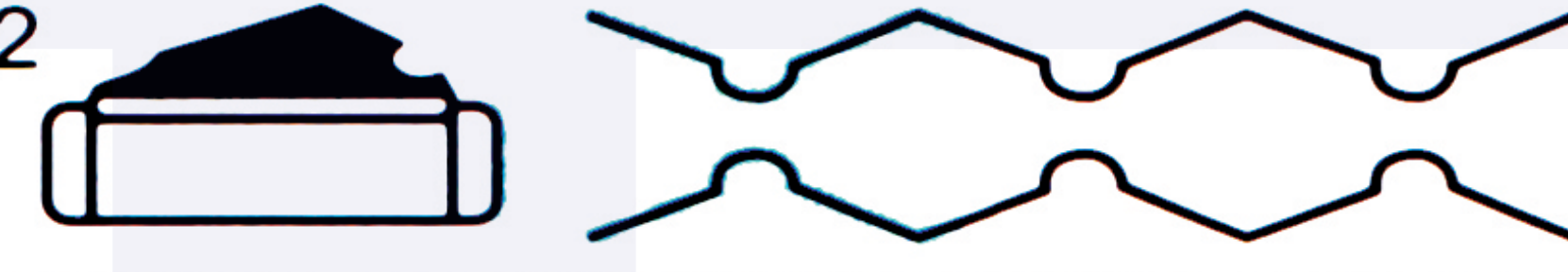
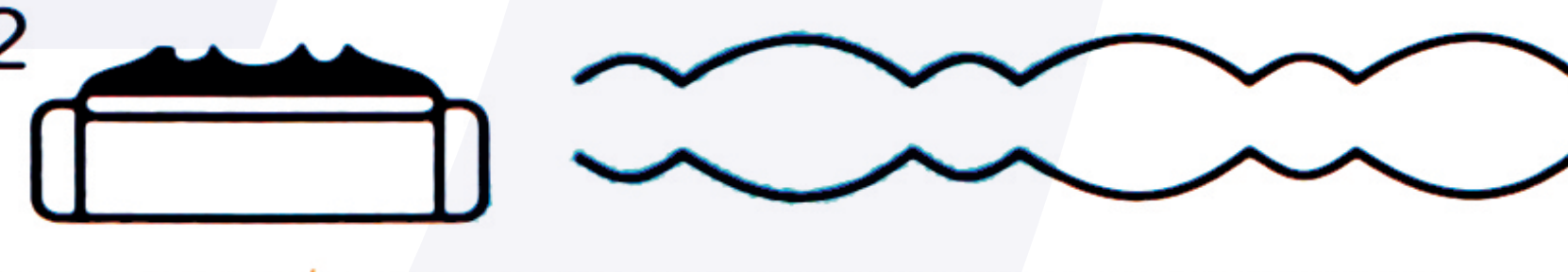
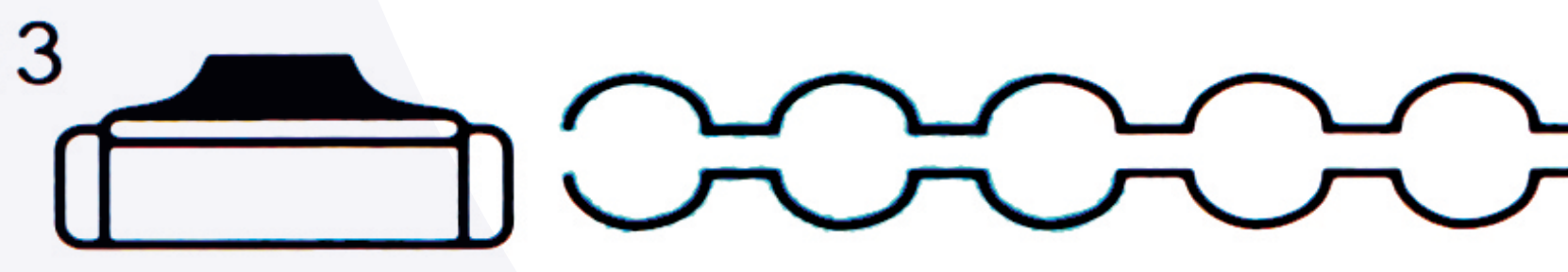
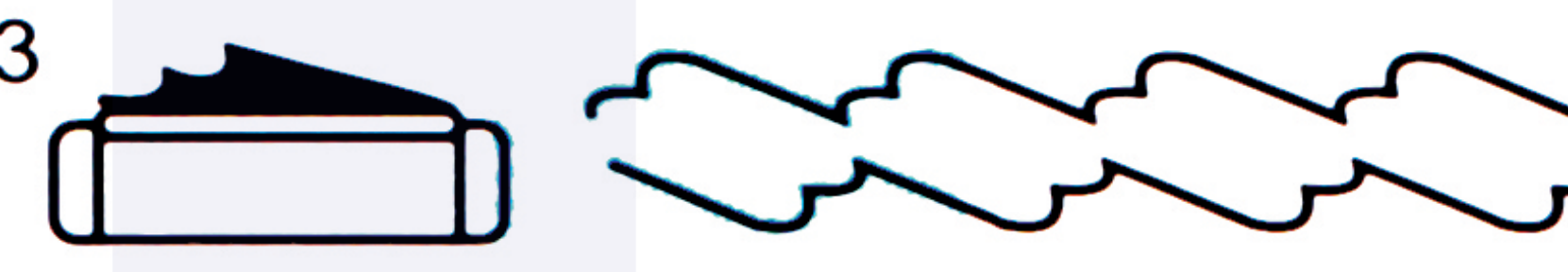
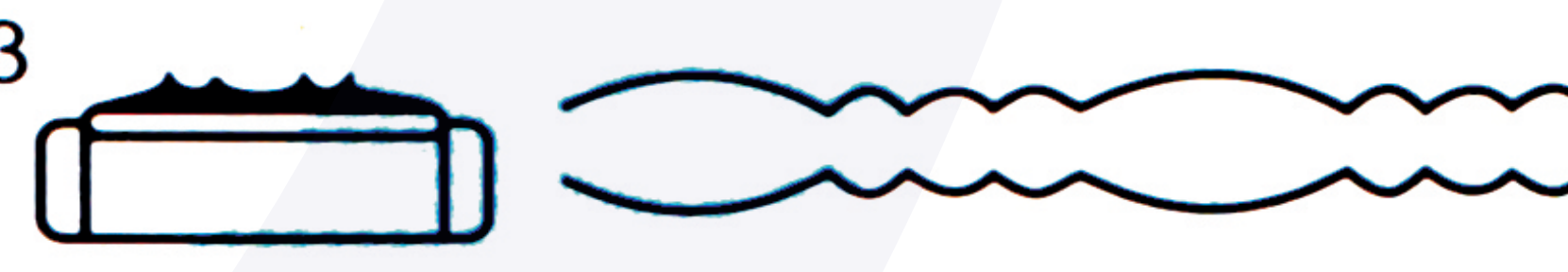
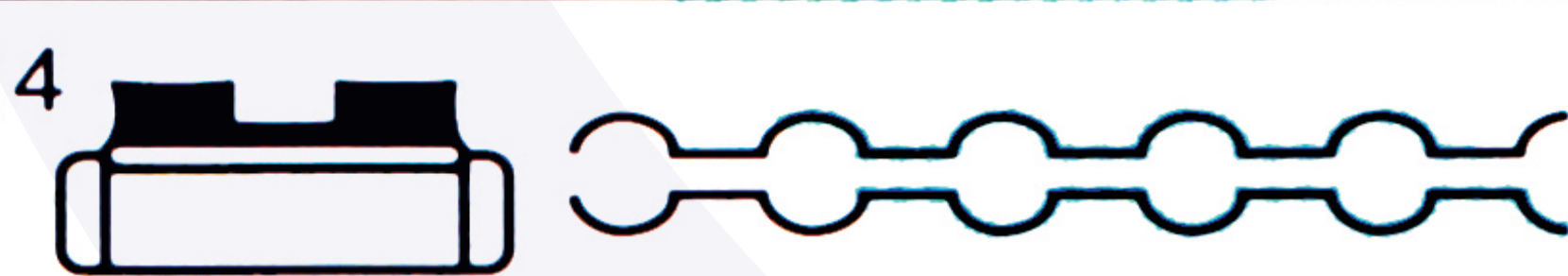

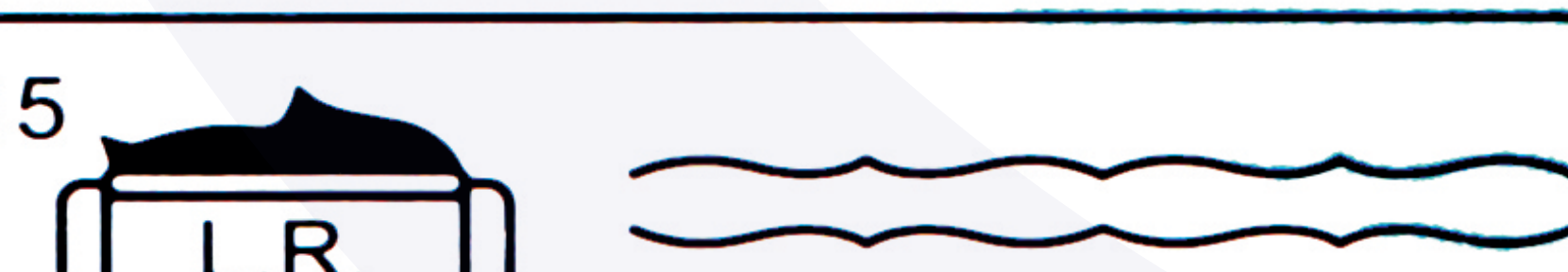
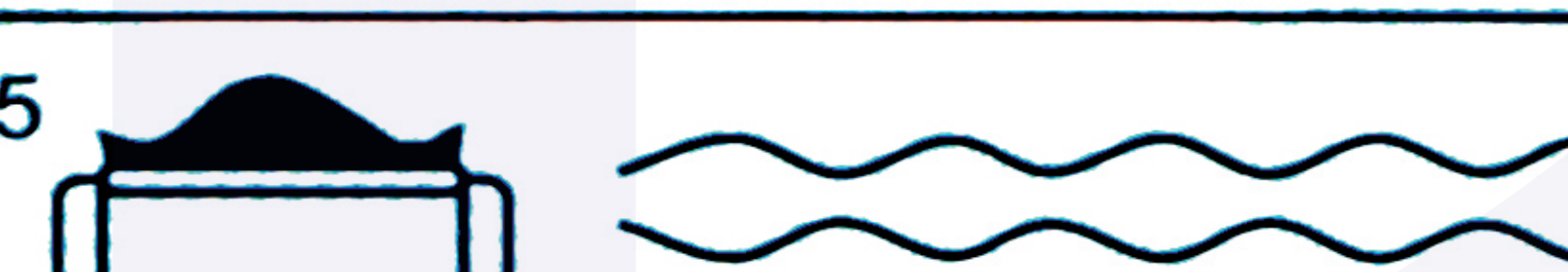
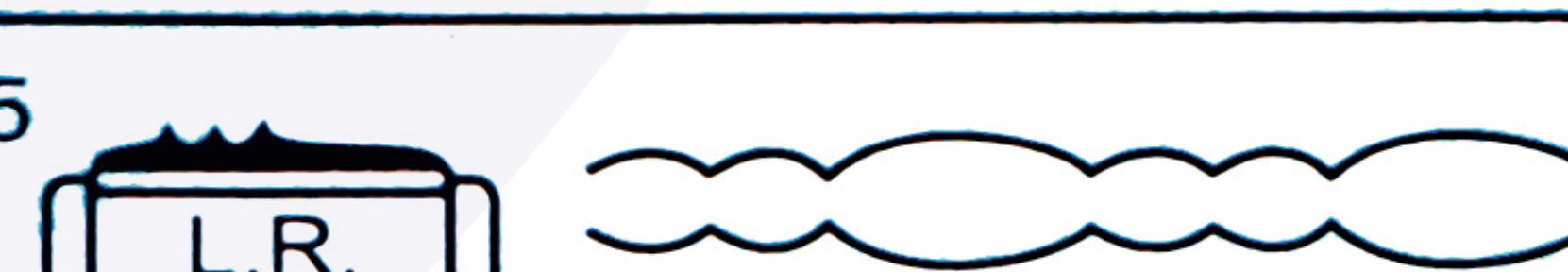
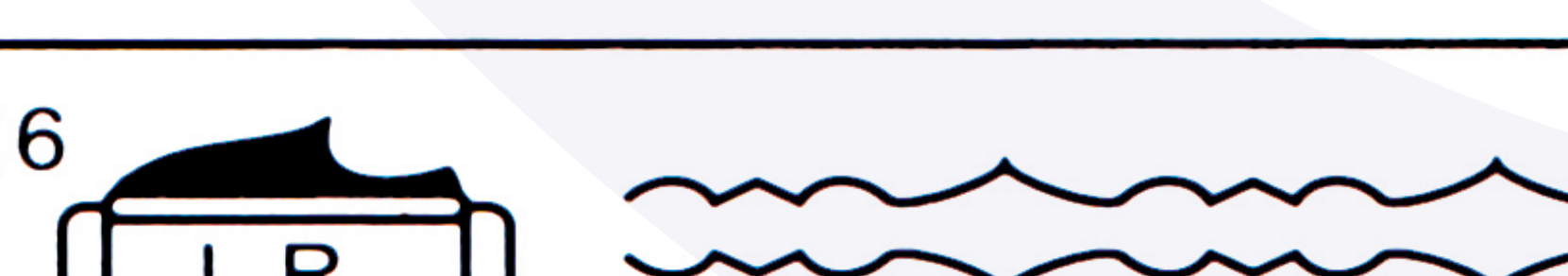
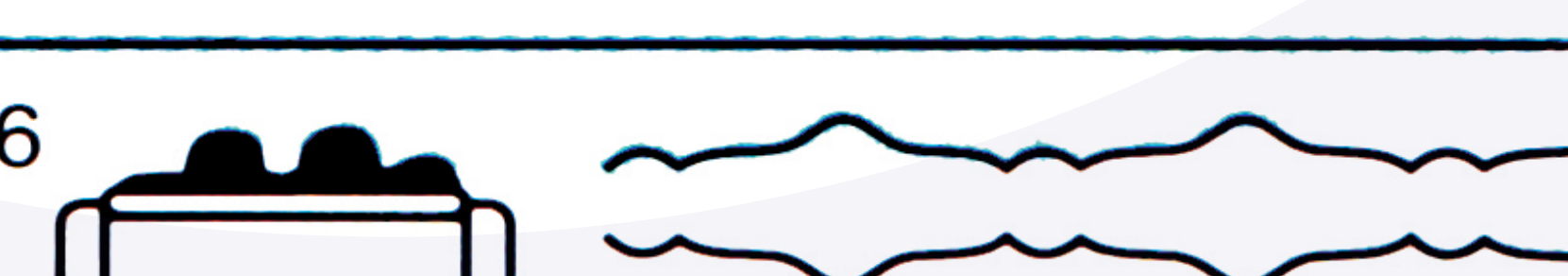
☎ : (0)+91 86558 55755 ✉ : SHAHTOOLS9@GMAIL.COM / SHAHTOOLS9@YAHOO.IN 🌐 : WWW.SHAHTOOLS.COM

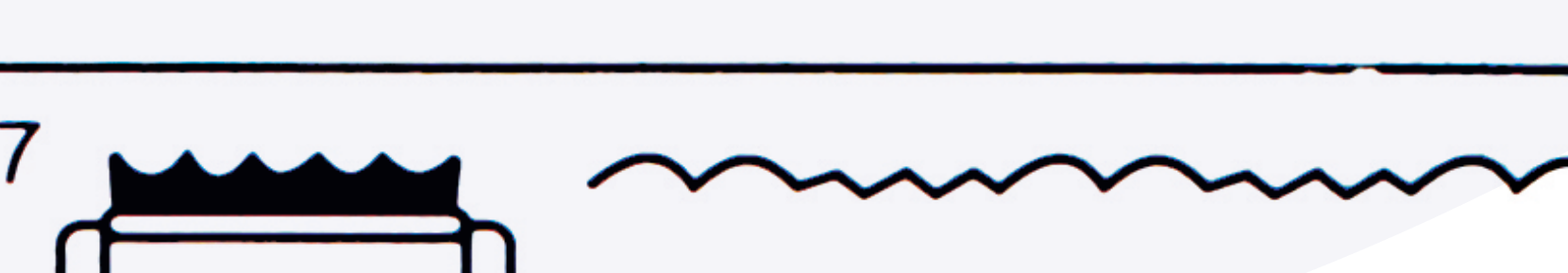

SHAH TOOLS®

MFG.: POSALUX & P.C.D. TOOLS, VACCUM TOOLS, C.N.C. TOOLS, ENDMILLS, ALL TYPE OF CARBIDE TOOLS

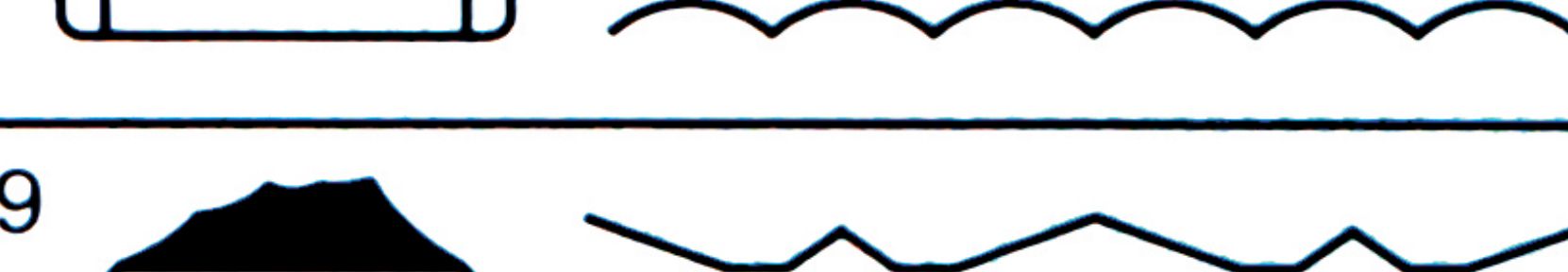
A BRAND YOU CAN TRUST

1 	21 	41 
2 	22 	42 
3 	23 	43 
4 	24 	44 
5 	25 	45 
6 	26 	46 
7 	27 	47 
8 	28 	48 
9 	29 	49 
10 	30 	50 
11 	31 	51 
12 	32 	52 
13 	33 	53 
14 	34 	54 
15 	35 	55 
16 	36 	56 
17 	37 	57 
18 	38 	58 
19 	39 	59 
20 	40 	60 

📍 : D - 2, OMKAR GHS. LTD., PLOT NO. - 24, NEAR MANGAL MURTI HOSPITAL, NEXT TO KALA HANUMAN TEMPLE, RSC - 22, GORAI (1), BORIVALI (WEST), MUMBAI - 400 092. INDIA.

☎ : (0)+91 86558 55755 ✉ : SHAHTOOLS9@GMAIL.COM / SHAHTOOLS9@YAHOO.IN 🌐 : WWW.SHAHTOOLS.COM



SHAH TOOLS[®]

MFG.: POSALUX & P.C.D. TOOLS, VACCUM TOOLS, C.N.C. TOOLS, ENDMILLS, ALL TYPE OF CARBIDE TOOLS

A BRAND YOU CAN TRUST



C. N. C. TOOLS:

Types : Engraving (180), Dull Bindi, V Bindi, Cone, Ball, Dragon, Batman etc.

Shank Sizes : Standard 6mm.

Customization : as per your Requirement



C. N. C. CARBIDE ENDMILL CUTTER :

Size : 0.3 mm to 3 mm, 4 mm, 6 mm

Flute : 2 Flute

Shank Size : 3 mm, 4 mm,



C. N. C. CARBIDE BACKGROUND TOOLS :

Flute : 1 F, 2 F, 4 F

Shank Size : 4 mm

Clock & Anti Clock



Diamond Point Pen

📍 : D - 2, OMKAR CHS. LTD., PLOT No. - 24, NEAR MANGAL MURTI HOSPITAL, NEXT TO KALA HANUMAN TEMPLE,
RSC - 22, GORAI (1), BORIVALI (WEST), MUMBAI - 400 092. INDIA.

☎ : (0)+91 86558 55755 ✉ : SHAHTOOLS9@GMAIL.COM / SHAHTOOLS9@YAHOO.IN 🌐 : WWW.SHAHTOOLS.COM